

# 1998-2002 GM LS1 F-Body H.O. Intercooled System **Installation Guide**





The **ULTIMATE** Power Adder™

Accessible Technologies, Inc.  
 14801 W. 114th Terrace  
 Lenexa, KS 66215  
 Phone: 913.338.2886  
 Fax: 913.338.2879  
 techserv@procharger.com

All rights reserved. Accessible Technologies Inc. hereby grants permission to use and reproduce this document for personal use, provided that all copyright information be retained. Reproduction of this document for unauthorized commercial use is strictly prohibited.

Information in this document is subject to change without notice.

ProCharger is a registered trademark and The Intercooled Supercharging Experts!<sup>TM</sup> and Designed to Blow Away the Competition<sup>TM</sup> are trademarks of Accessible Technologies, Inc. and may not be used without express permission.

Torque Specification Chart	 Grade 5			 Grade 8		
	Thread Size	Torque (lb. ft.)			Torque (lb.ft.)	
1/4-20	11	8	7	16	12	10
1/4-26	13	10	8	18	14	11
5/16-18	23	17	14	33	25	20
5/16-24	26	19	15	36	27	22
3/8-16	41	31	25	58	44	35
3/8-24	47	35	28	66	49	39
7/16-14	66	49	40	93	70	56
7/16-20	74	55	44	104	78	62
1/2-13	101	75	60	142	106	85
1/2-20	113	85	68	160	120	96

# INTRODUCTION

Congratulations on purchasing your ProCharger® 1998-2002 GM LS1 F-Body High Output System. Read this entire manual before you attempt to install your ProCharger kit. It is imperative that you follow all of the instructions in the order they appear in this installation guide. If you have any questions regarding any aspect of this installation, call us at (913) 338-2886.

For best results, we recommend reviewing the installation instructions beforehand, and following the installation instructions closely and in sequence. A detailed packing list has been provided to assist you in identifying the components of your ProCharger system.

## Required Tools and Supplies

- 3/8" & 1/2" Socket Set (standard & metric)
- 1/2" Breaker Bar & 4" Extension
- Adjustable Wrench
- #20 Torx Bit Wrench
- Hex Bit Wrench
- Pliers
- Open End Wrench Set (standard & metric)
- Flat & Phillips Screwdrivers
- Large Screwdriver or Crowbar
- Drill & Drill Bit Set
- Factory Repair Manual



**Warning:** *Your supercharged GM F-Body must always be run on 91 octane or better gas.*

You should also have the following gauges available to properly check the finished installation and monitor your vehicle's performance (especially for testing):

- Manifold Boost Pressure Gauge
- Fuel Pressure Gauge
- Wide Band Oxygen Sensor and Gauge

Gauges should be of a type that can be read from the cockpit while performing a wide-open throttle road test. Cockpit or hood-mounted gauges are preferable. In order to obtain usable readings, the gauges should measure pressure at the intake manifold and fuel rail. **IF VEHICLE DOES NOT MAINTAIN PROPER FUEL PRESSURE (50-65 PSI), DECREASE THROTTLE APPLICATION IMMEDIATELY.** In some cases, extra vehicle modifications can strain the stock fuel pump. If your vehicle has difficulty retaining adequate fuel pressure, contact ATI ProCharger about the availability of an upgraded fuel system.

The engine on which the ProCharger® is to be installed should retain the factory compression ratio. If it has been modified in any way, please consult ProCharger staff before proceeding with the installation. This supercharger system is intended for use on STOCK, strong, well-maintained engines/transmissions. Installation on a worn or troublesome powertrain should be reconsidered. **ATI PROCHARGER WILL NOT BE HELD RESPONSIBLE FOR DAMAGE TO A VEHICLE'S POWERTRAIN.** ATI ProCharger is not responsible for ECM tuning/programming on non-stock vehicles. ATI PROCHARGER recommends verifying that your vehicle has current ECM updates from the vehicle manufacturer before installation.

For best performance and reliability, always use premium grade fuel (91 octane or higher) and listen closely for signs of detonation, which might sound like ball bearings rolling around in a tin can. **IF DETONATION SHOULD OCCUR, OR IF YOU ARE UNSURE WHETHER WHAT YOU'RE HEARING IS DETONATION, DECREASE THROTTLE APPLICATION IMMEDIATELY** and please consult ATI ProCharger staff. Detonation should not be an issue with a properly installed intercooled supercharger system, though OEM factory-shipped engine and parts inconsistencies are possible on any vehicle.

# TABLE OF CONTENTS

Introduction .....	i
Table of Contents.....	ii
Tuning .....	1
Getting Started.....	3
Crank Pulley .....	6
Air Pump/Cruise Control Relocation .....	9
Horn Relocation .....	12
Cooling Fan.....	13
ProCharger and Bracket.....	14
Intercooler and Tubing.....	21
Fuel System .....	28
Final Assembly .....	34
Installation Review/Safety Check .....	35
Operation and Maintenance .....	36
Limited Warranty .....	38
ProCharger Extended Coverage .....	39

**PLEASE PROCEED TO THE TUNING SECTION FOR COMPLETE SYSTEM INSTALLATIONS. TUNING THESE VEHICLES IS A MULTI STEP PROCESS THAT SHOULD BE INITIATED BEFORE SYSTEM INSTALLATION BEGINS. PLEASE ALLOW 24 HOURS TO RECEIVE YOUR MODIFIED TUNE FILE. CONTACT ATI WITH ANY QUESTIONS REGARDING TUNING FOR THESE VEHICLES.**

**!** **CAUTION:** *Never use a mechanical fuel pressure gauge inside the vehicle without a fluid separator, which will keep the fuel isolated to the engine compartment. Serious bodily injury or death could result from fuel inside the vehicle’s passenger compartment.*

# TUNING



**Note:** This section only applies to full systems, which include a handheld tuner. If you do not have a full system, additional tuning will be required before starting the vehicle.

## inTune Programmer



**Warning:** Voltage fluctuations are a common cause of reflashing failure. Be sure your battery is fully charged, remove the cooling fan and fuel pump fuses, keep the stereo off, and do not open or close any doors or windows while reflashing.



**Warning:** During a reflashing, either stay in the vehicle or open a window prior to reflashing to prevent getting locked out.

- 1) Remove the inTune programmer from its box and review the included instructions for updating your device.
  - 1) Connect the inTune programmer to your PC with the provided USB cable. Allow the device to load drivers to the PC.
  - 2) Run the inTune updater software.
- 2) Connect the inTune programmer to the OBD-II port located below the steering column using the OBD-II cable included with your programmer.
- 3) Upload your stock tune from the ECM to the inTune programmer:
  - 1) Select **Tune Vehicle**
  - 2) When prompted turn the key to the on position without starting the engine
  - 3) Select Advanced Tune
  - 4) Select Install Standard Tune
  - 5) Select Modify Stock Tune
- 4) Follow the on screen prompts. Your original backup will be saved.
  - 1) Select Backup Only
- 5) Connect the inTune programmer to your PC with the provided USB cable. A window will appear showing the inTune as an additional storage device.
  - 1) Select Open Files
  - 2) Select Tunes
  - 3) Select VIN Folder
  - 4) Click and drag the Original Backup file to your PC's desktop or hard drive
- 6) Email the **Original Backup** file to [tuning@procharger.com](mailto:tuning@procharger.com) with the ProCharger serial number in the subject line.
- 7) You will receive the tune for your vehicle within 24 hours. Save the modified tune to your desktop or hard drive.

- 8 Connect the inTune programmer to your PC and open the inTune drive:
  - 1) Click and drag the ProCharger Tune file from your desktop or hard drive to the inTune drive.
  - 2) Allow the file time to load, do not disconnect before the file has finished loading
- 9 Connect the inTune programmer to the OBD-II port located below the steering column.
- 10 Download the modified tune from the inTune programmer to your vehicle:
  - 1) Select **Tune Vehicle**
  - 2) Select **Advanced Tune**
  - 3) **Install Custom Tune**
  - 4) **Select Procharger**
  - 5) **Select Apply Tune**
- 11 Follow the on-screen prompts:
- 12 The ProCharger tune will now be written to your vehicle. This process can take several minutes.



### **Troubleshooting:**

•If the programmer fails to install the tune to your vehicle for any reason, it will enter into "VEHICLE RECOVERY MODE." Reprogram the vehicle with the "RESTORE VEHICLE" option before attempting to install the ProCharger Tune again.

# GETTING STARTED

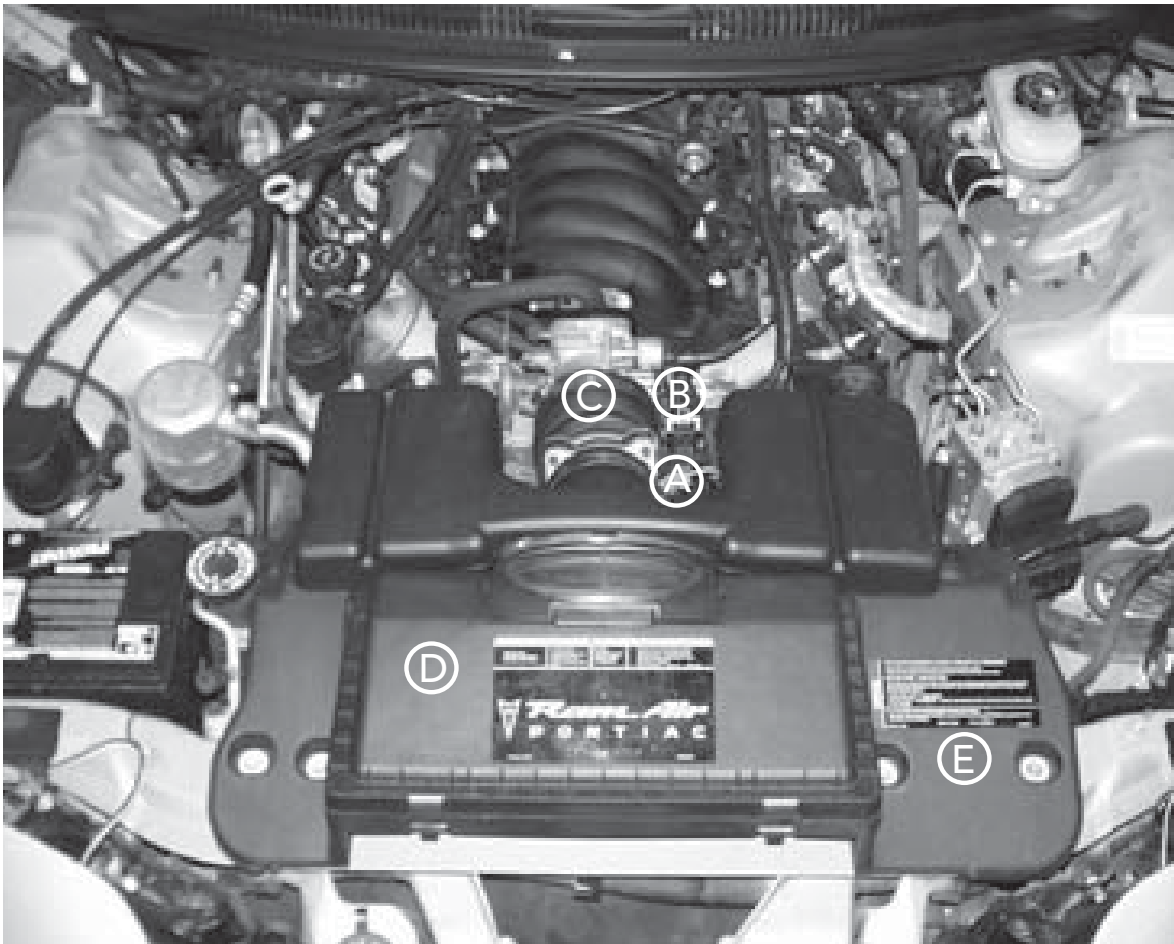

Completion of this section will configure the vehicle for system installation:

- (A) Air Temperature Sensor
- (B) Mass Air Flow Meter (MAF)
- (C) Air Intake Flex-Hose
- (D) Upper Air Filter Assembly
- (E) Lower Air Filter Assembly

**!** *Read and understand all safety precautions in this manual before installation. Failure to comply with instructions in this manual could result in personal injury, property damage, and/or voiding your warranty.*

## Getting Started



**Tech Tip:** Removing the sway bar will make more clearance for installing the supercharger system.

- 1 Replace the factory spark plugs with ones that are one heat range cooler than stock. Gap the plugs to .035".
- 2 Remove the gas cap to relieve fuel tank vapor pressure.
- 3 Remove the fuel pump fuse from the fuse block. Crank the engine for a few seconds to bleed fuel pressure from the fuel lines. Replace the fuse.
- 4 Disconnect the negative battery cable from the battery.
- 5 If the vehicle has had any modifications done to the Powertrain Control Module (PCM), return the computer to factory settings before proceeding.



**WARNING:** Aftermarket chips/programmers for naturally aspirated motors advance timing at elevated RPM's; this will cause detonation and engine damage if used with a supercharger. Many aftermarket chips/programmers also extend your RPM range. Since boost is related to engine RPM, this can produce excessive boost and engine damage.

- 6 Unplug the air temperature sensor and Mass Air Flow (MAF) meter wiring from the wiring harness. Loosen the hose clamp that attaches the air intake flex-hose to the throttle body using an 8mm nut driver, and pull the flex-hose forward off of the throttle body. Remove the four bolts that attach the air filter assembly to the radiator core support using a 10mm socket and ratchet. Remove the entire air inlet tract which includes the air filter assembly, MAF meter and flex-hose as one piece and set aside.
- 7 Taking care to protect the wire elements and screen inside the MAF meter, remove the MAF meter from the flex-hose and the air inlet noise baffle, using an 8mm nut driver and a large flat screwdriver respectively.
- 8 Raise the front of the vehicle and secure with jack stands.

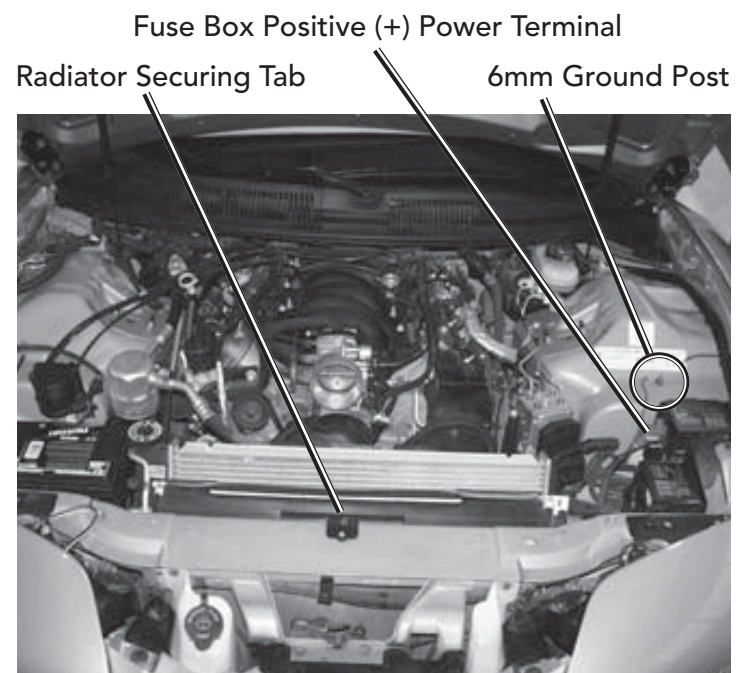

Factory Air Inlet Removed



- 9 Remove the plastic radiator air dam and both driver's and passenger's side vented splash panels from beneath the car and set aside. Be sure to keep the screws that retain the factory splash panels; they will be reused later on in the installation.
- 10 Cut the plastic radiator air dam at the two marked locations shown. The cut lines are approximately 1" on either side of the outer most holes.
- 11 Remove the wiring clips from both fan motors, using a flat head screwdriver to depress the tangs on the wiring clips to allow them to slide out.
- 12 Remove the fan wiring loom from the five retaining clips that are attached to the fan shroud.
- 13 From the top of the vehicle, remove the radiator hose from the plastic retaining clip on the upper side of the factory fan shroud.

✓ **Note:** There is no need to disconnect any of the radiator hoses during this process.

- 14 Remove the factory fans and fan shroud from the engine compartment as one piece, by pushing upward on the shroud until it is free of the four retaining clips on the sides of the radiator, and then carefully lowering the entire assembly out from underneath the vehicle. Be careful not to damage the radiator or radiator fins during removal.

✓ **Note:** For Race Intercooler prep., see the enclosed supplemental installation manual.



Stock Plastic Flap w/Cut Lines Shown

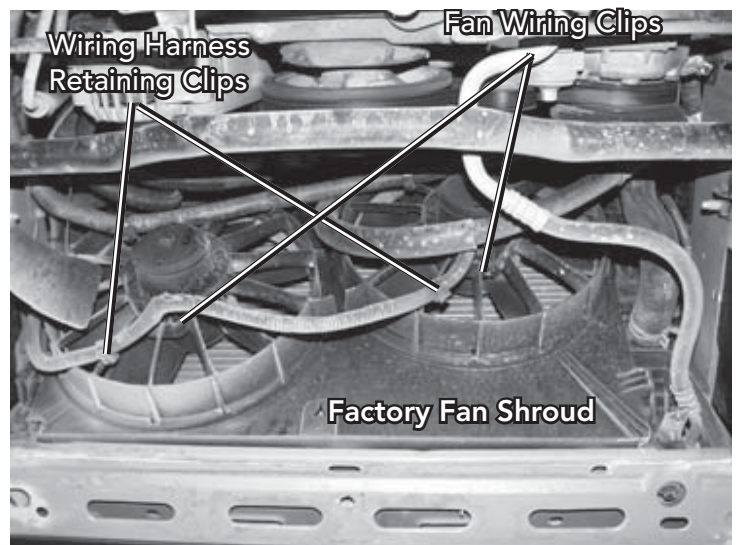

Factory Fan/Shroud Assembly (Installed)



Factory Fan/Shroud Assembly (Removed)

# CRANK PULLEY

- ✓ **Note:** Pinning the balancer to the crankshaft is recommended for 6-rib kits and required for 8-rib kits.

## 6-rib only 8 and 10 rib proceed to step: 10

- 1 Remove the factory harmonic balancer retaining bolt using a 24mm socket and impact wrench or breaker bar.
- 2 Install the optional harmonic balancer pinning tool using the supplied M16 hex bolt as shown (proceed to step 7 if not pinning the crank).
- 3 Tighten the bolt to hold the tool in place and prevent spinning during the drilling process.
- 4 Using the supplied 1/4" HSS drill bit, drill a hole in the crankshaft/harmonic balancer 0.800" deep from the face of the crankshaft. The hole will be centered on the O.D. of the crankshaft. Do not drill deeper than 0.800". Remove the pinning tool and set aside.
- 5 Using compressed air, blow out the hole to insure no chips or debris are present.
- 6 Install the supplied 1/4" O.D. x 0.750" long stainless steel dowel pin in the hole.



Pinning Tool Installation  
(Factory Balancer Shown)

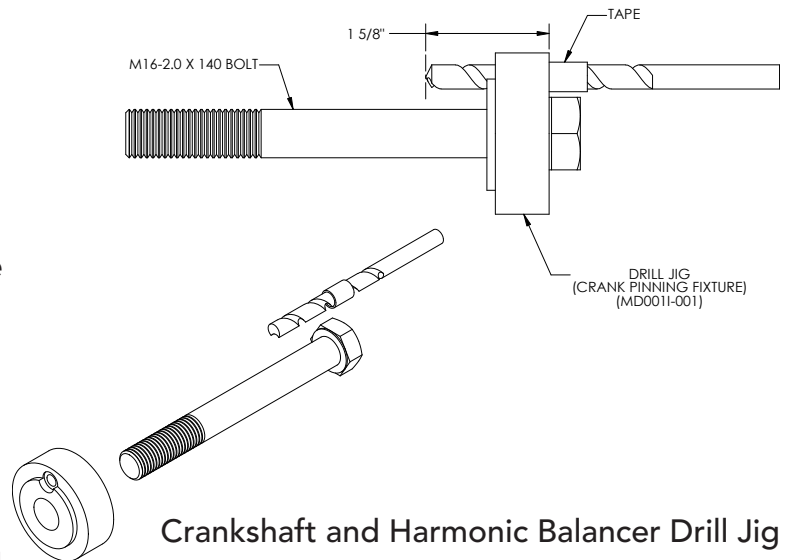

Crankshaft and Harmonic Balancer Drill Jig



Harmonic Balancer Pinned to Crankshaft

- 7 Clean the inside face of the factory harmonic balancer using solvent and a wire brush. This is very important to ensure that the supplied pulley will sit flush once installed.
- 8 Install the supplied billet aluminum crank pulley, using the provided grade 14.4, M16-2.0 x 140 hex head cap screw and washer, making sure that the crank pulley dowel pins are sitting between the dampener spokes, and that it is rotated counter-clockwise until the dowel pins touch the dampener spokes. Make sure the pulley is sitting flush on the dampener.
- 9 Tighten and torque the new crank pulley center bolt to 40 ft/lbs. Now turn the bolt an additional 120° of rotation (1/3 of a revolution). Verify that the face of the ATI crank pulley is now parallel with the face of the factory harmonic balancer.

**Proceed to page 9.**

Factory Balancer Retaining Bolt



Factory Harmonic Balancer

Supplied 6-rib Aluminum Crank Pulley  
M16-2 x 140 Hex Bolt      M16 Flat Washers

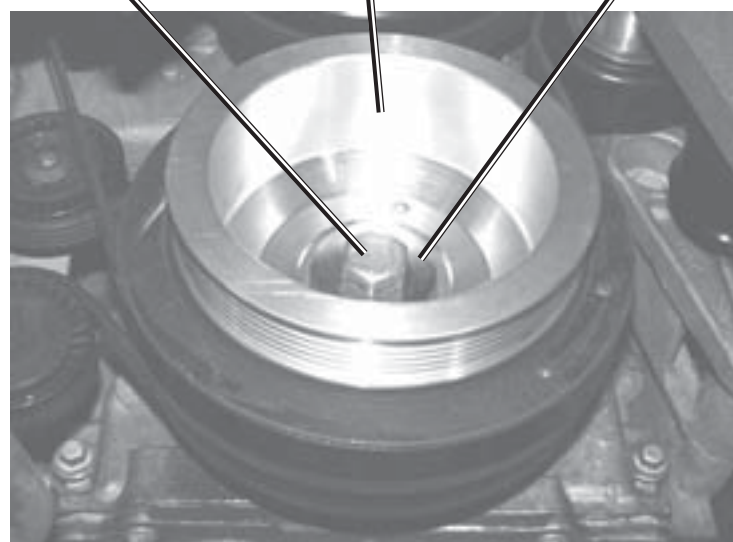

Supplied Crank Pulley Installed

## Crank Pulley

- ✓ **Note:** The 8-Rib Upgrade requires ATI Performance Products LS1 Harmonic Balancer (Part #918853).

### 8-rib and 10-rib upgrade only:

- 10 Remove the stock harmonic balancer using GM tools J-41816 (LS1 Crankshaft Balancer Remover) and J-41816-2 (LS1 Crankshaft End Protector) according to the instructions shown in the factory service manual, being careful not to damage the crankshaft center bolt threads.
- 11 Clean the crankshaft using solvent and a soft brush, being careful not to damage the crank shaft surface.
- 12 Install the ATI Performance Products harmonic balancer in accordance with the instructions provided by the manufacturer (do not install the balancer retaining bolt at this time).
- 13 Following steps 2-6 on the previous page, pin the balancer to the crankshaft. Install the balancer retaining bolt.
- 14 Install the supplied 8-rib crank pulley to the ATI PP harmonic balancer using the supplied 3/8"-16 x 1-1/2" SHCS and 3/8" heavy flat washers using red loctite, making sure to align the pilot surface on the back of the pulley with the balancer.
- 15 Confirm the pulley is sitting flush with the new harmonic balancer face and is running true.
- 16 Re-install the A/C belt at this time.

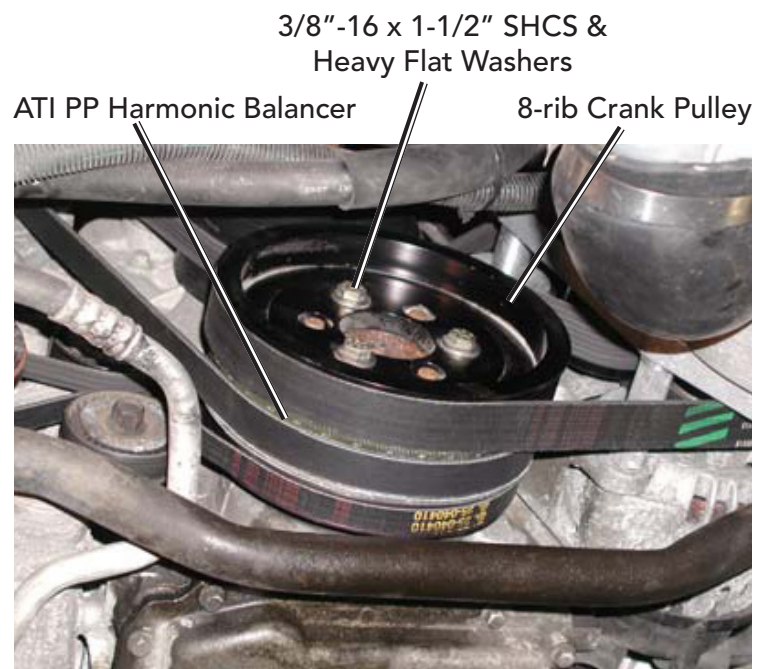

ATI PP Harmonic Balancer & 8-rib Crank Pulley Installed



ATI Balancer Pinned

# AIR PUMP/CRUISE CONTROL RELOCATION

## 1998-1999 model years

- 1 Near the driver's side splash panel, remove the (4) bolts holding the air pump bracket to the frame.
- 2 Unplug the wiring from the pump and pull off the inlet and outlet hoses. The hoses are held on by plastic clamps that unlock by pushing one end to the side and the other end to the opposite side. Using pliers can make them much easier to remove.
- 3 Remove the short inlet filtration hose and filter, they will not be reused. If present, remove the sensor from the bracket by disconnecting the wiring and pulling off the vacuum line. Use a flat head screwdriver to release the tab that holds the sensor to the bracket and slide the unit off. Set it aside, as it will be transferred to the new bracket.
- 4 Remove the (3) bolts holding the air pump to its bracket and remove the pump.
- 5 Re-install the air pump to the supplied relocation bracket using the supplied 1/4-20 x 1-1/4" bolts, nuts, and washers. Mount the pump so that its mounting tabs are on the bottom side of the bracket. Re-install the sensor (if applicable) onto the new bracket by sliding it onto its mount and bending the tab inward.
- 6 Follow the cruise control cable from the cruise control box towards the top of the engine compartment. Halfway along the line there is a plastic retainer that holds the cable to the frame. Using a flat head screwdriver or needle nose pliers, remove this retainer and carefully work the cable a little to gain some slack. It may be much easier to work the cable from the top of the engine bay.
- 7 Disconnect the electrical wiring from the cruise control and remove the (3) bolts holding the cruise control bracket to the car. Carefully support the assembly.
- 8 Now remove the (3) bolts holding the cruise control to its bracket. Carefully support the cruise control unit.
- 9 A, B, and C are the mounting points for the relocation bracket. Loosen nuts A and B as shown. Use the supplied M6 x 20 bolt at mounting point C. Reroute the wiring for the cruise control so that it falls down through the larger hole. The fuse box assembly can be moved over after pulling up on it to release it from its clips.

## Air Pump/Cruise Control Relocation

- 10 Support the relocation bracket (with the air pump already installed) in the general area where the cruise control was originally mounted. Install the cruise control onto the bracket using the supplied 1/4 - 20 x 1-1/4" bolts, nuts and washers.
- 11 Install the supplied filter to the inlet of the air pump using the supplied 90° hose and hose clamps. The 90° hose can be cut/modified to allow the filter to fit in the crowded area where the relocation bracket will sit. Some test fitting might be a good idea.
- 12 Reattach the outlet hose to the pump. It can be rerouted if need be.
- 13 Reattach all electrical connections to both the air pump and cruise control. Reconnect (if applicable) the sensor's electrical and vacuum connections.
- 14 Bolt the bracket into place.

✓ **Note:** For Trans Ams, use the supplied .343" long spacers and 1/4 - 20 x 1-1/2" bolts to tilt the air pump away from the parking light location.

### 2000-2002 model years

- 1 Near the driver's side splash panel, remove the (4) bolts holding the air pump bracket to the frame.

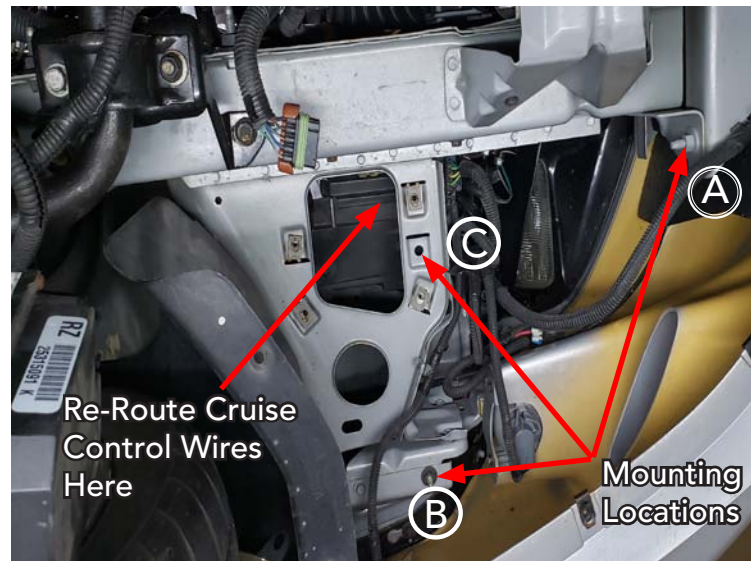

Air Pump & Cruise Control Relocation Bracket Mounting Locations

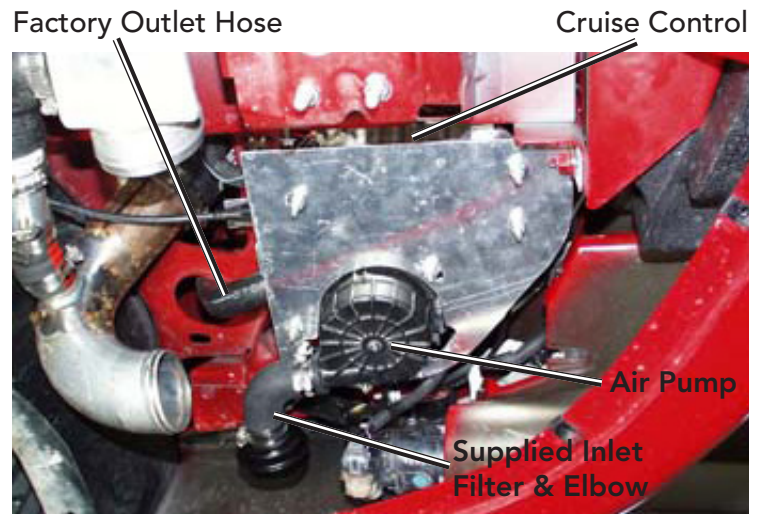

Relocation Bracket Installed

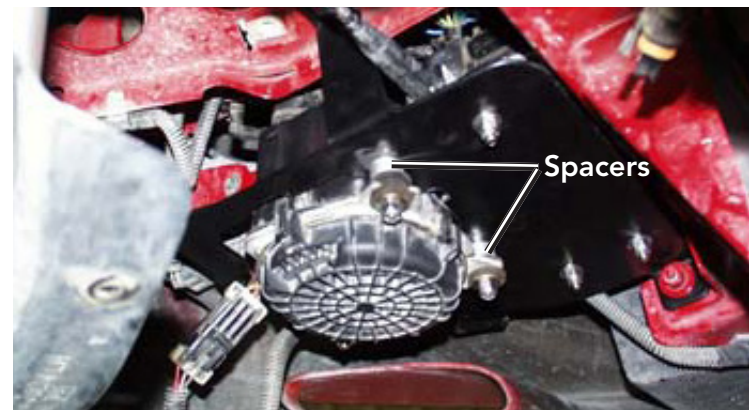

Relocation Bracket w/Spacers Installed

- 2 Unplug the wiring from the pump and pull off the inlet and outlet hoses. The hoses are held on by plastic clamps that unlock by pushing one end to the side and the other end to the opposite side. Using pliers can make them much easier to remove.
  - 3 Remove the short inlet filtration hose and filter, they will not be reused.
  - 4 Remove the (3) bolts holding the air pump to its bracket and remove the pump.
  - 5 Re-install the air pump to the supplied relocation bracket using the supplied 1/4-20 x 1-1/4" bolts, nuts, and washers. Mount the pump so that its mounting tabs are on the bottom side of the bracket.
  - 6 Follow the cruise control cable from the cruise control box towards the top of the engine compartment. Halfway along the line there is a plastic retainer that holds the cable to the frame. Using a flat head screwdriver or needle nose pliers, remove this retainer and carefully work the cable a little to gain some slack. It may be much easier to work the cable from the top of the engine bay.
  - 7 Disconnect the electrical wiring from the cruise control and remove the (3) bolts holding the cruise control bracket to the car. Carefully support the assembly.
  - 8 Now remove the (3) bolts holding the cruise control to its bracket. Carefully support the cruise control unit.
  - 9 A, B, and C are the mounting points for the relocation bracket. Loosen nuts A and B as shown. Place the supplied 5/16 - 18 x 1" bolt with washer through hole C from the top. Reroute the wiring for the cruise control so that it falls down through the larger hole. The fuse box assembly can be moved over after pulling up on it to release it from its clips.
  - 10 Support the relocation bracket (with the air pump already installed) in the general area where the cruise control was originally mounted. Install the cruise control onto the bracket using the supplied 1/4 - 20 x 1-1/4" bolts, nuts and washers.
  - 11 Install the supplied filter to the inlet of the air pump using the supplied 90° hose and hose clamps. The 90° hose can be cut/modified to allow the filter to fit in the crowded area where the relocation bracket will sit. Some test fitting might be a good idea.
  - 12 Reattach the outlet hose to the pump. It can be rerouted if need be.
  - 13 Reattach all electrical connections to both the air pump and cruise control.
-  **Note:** For Trans Ams, use the supplied .343" long spacers and 1/4 - 20 x 1-1/2" bolts to tilt the air pump away from the parking light location.

## HORN RELOCATION

- 1 Near the driver's side splash panel, unclip the the wires going to the horns.
- 2 Remove the (2) nuts holding the horns onto the factory bracket and remove the horns. Also remove the factory horn bracket at this time.
- 3 Re-install the horns onto the supplied bracket using the factory nuts. Slide the supplied M8 x 30 bolts with washers into the upper holes and install the supplied spacers on the back side of the bracket.

✓ **Note:** On some model years, the forward most hole is not tapped. Use an M8 tap to tap the hole or use the supplied 5/16 x 1-1/4" thread cutting screw in place of the M8 x 30 bolt.

- 4 Re-install the assembly using the (2) hole locations shown and clip the wiring back onto the horns.

✓ **Tech Tip:** The Vacuum cannister may need to be relocated on 4.5" intercooler setups as shown below.

Use M8 Tap or Thread Cutting Screw If Needed



Horn Relocation Holes  
(Shown with Horns Removed)

0.375" Spacer/M8 x 30mm Bolt  
(For 4.5" I/C use 1.20" Spacer/M8 x 55mm Bolt)

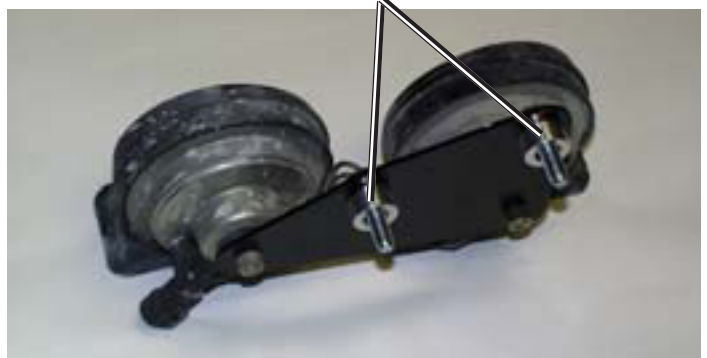

Horn Installed on Relocation Bracket

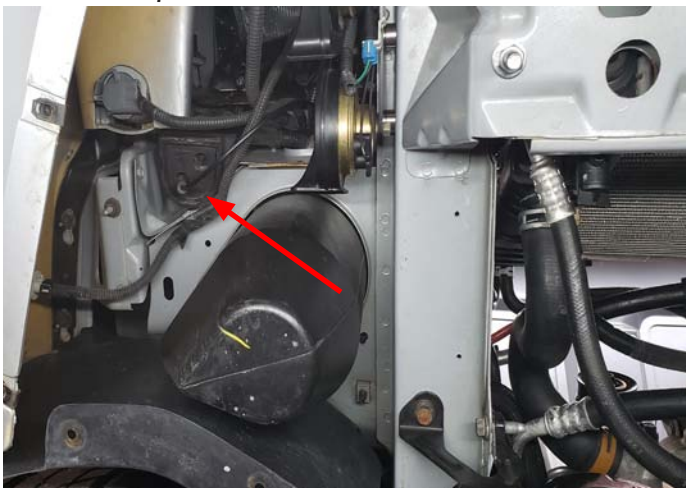

Relocated Air Pump



Relocated Horns



## COOLING FAN

- 1 Assemble the upper and lower fan shroud sections using the (5) supplied 1/4" x 3/4" bolts washers and lock-nuts.
- 2 Attach the supplied 16" cooling fan to the supplied sheet metal fan shroud using the supplied fasteners 1/4" x 1" bolts washers and lock-nuts.
- 3 Install the supplied sheet metal shroud and cooling fan by reversing the factory fan/shroud removal steps.
- 4 Attach the supplied wiring harness to the factory fan wiring harness. Splice the blue harness flying lead to the blue fan wire and the black harness flying lead to the black fan wire. Use the supplied solder connectors to secure the splice. Use the supplied heat shrink and wire loom to protect the harness.

✓ **Tech Tip:** Use a heat source such as a heat gun to melt the solder in the solder connector. Be sure the solder penetrates both wires and the outer casing shrinks over the wires.

- 6 Install the supplied sheet metal radiator core support using the two factory M6 fasteners. Mark a hole on each side of this core support where it intersects the tabs on the top of the new fan shroud. Remove the support and drill each hole using a 5/32" bit. Re-install and attach the radiator core support to the fan shroud using the provided #12 sheet metal screws.

✓ **Note:** The sheet metal radiator core support will sit flush against the frame if the radiator securing tab is trimmed off. This step is optional.



Supplied Fan/Shroud Assembly

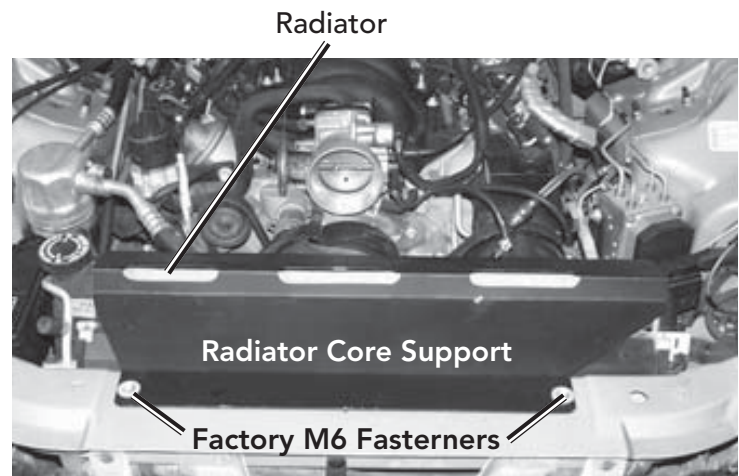

Radiator Core Support Installed

# PROCHARGER AND BRACKET

**!** **WARNING: Never strike the ProCharger pulley with a hammer or other tool under any circumstance! Evidence of such force will void the warranty, as serious damage to the precision bearings within the ProCharger could occur.**

**1** Remove the factory serpentine drive belt by using a 15mm wrench to rotate the factory rotary tensioner clockwise until the belt is loose. Hold in place and slide the belt off of the water pump pulley, leaving the belt wrapped around the lower pulleys. Slowly release the tensioner.

**2** Remove the two alternator bolts as shown at lower right and set aside. Replace these bolts with the two supplied hex standoffs (2.5" for 6-Rib, 2.75" for 8 and 3.0" for 10-rib) and M10 x 140 studs. Tighten the studs by hand until resistance is felt (approximately 1.0") and then thread the standoffs onto the studs. Torque to 40 ft/lbs. These will be 2 of the 3 mounting points for the main bracket.

**6-Rib proceed to next page, 8 and 10-rib proceed to page: 18**

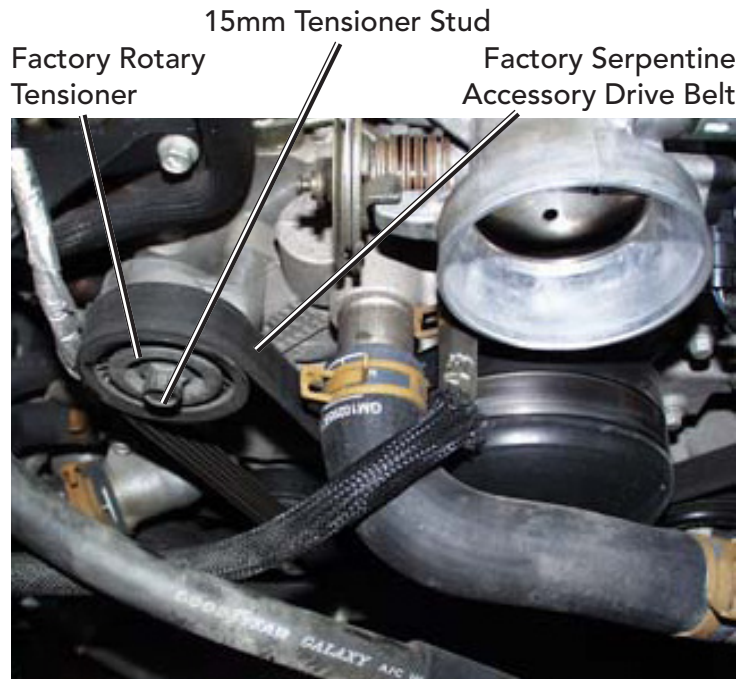

Factory Rotary Tensioner

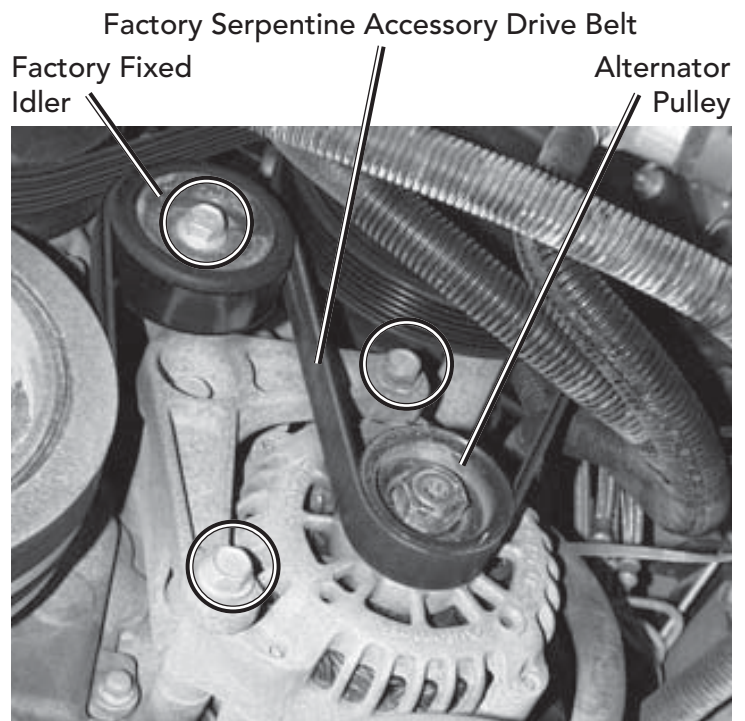

Main Bracket Mounting Points

## 6-rib applications only.

✓ **Note:** For automatic transmission vehicles, it will be necessary to disconnect the transmission cooler lines in order to install the supercharger belt. Disconnect the lines toward the front of the engine compartment where they change from hard to rubber lines. Some fluid will pour out; take safety precautions. Now slide the supercharger drive belt onto the lines and reconnect the lines. Be sure to check your fluid level before you drive the vehicle. The transmission cooler line securing tab will be reused at its existing location and it might be necessary to use the 2.40" hex standoff (also supplied) in place of the 2.50" hex standoff in order to allow the main bracket to sit flush (parallel to the front of the block).

- 3 Remove the factory idler pulley retaining bolt and stamped washer and set the bolt aside.

Idler Center Bolt Removed

2.5" Hex Standoffs



Main Bracket Standoffs Installed

Transmission Cooler Lines



Transmission Cooler Lines (Auto Trans)

Securing Tab

Lower Standoff Location/  
Lower Alt. Mounting Location



Transmission Cooler Lines & Securing Tab

## ProCharger and Bracket

- 4 Install the billet main bracket using the provided M10 x 25 bolts and flat washers to attach the bracket to the previously installed standoffs, making sure to loop the ProCharger 6-rib drive belt over the bottom standoff. Leave the bolts loose.
- 5 Attach the main bracket through the center of the factory idler using the supplied M10 x 100 hex bolt, flat washer, aluminum spacer and the stamped factory idler washer. Spacer length will be 1.5" or 1.625".
- 6 Tighten and torque all bolts.
- 7 Replace the factory belt using the reverse procedure outlined in step 1.
- 8 Make sure that the jack screw for the tensioner at the top of the main bracket is backed out to allow the tensioner assembly to slide all the way to the top unrestricted. Loosen the bolt at the rear of the tensioner just enough to allow it to slide. Place the ProCharger drive belt around the billet crank pulley.

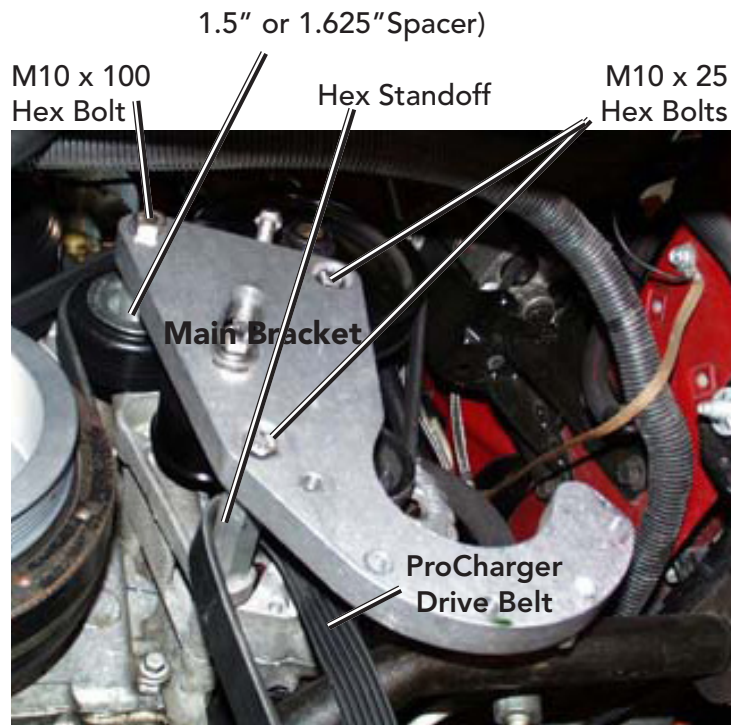

Main Bracket with Tensioner Installed

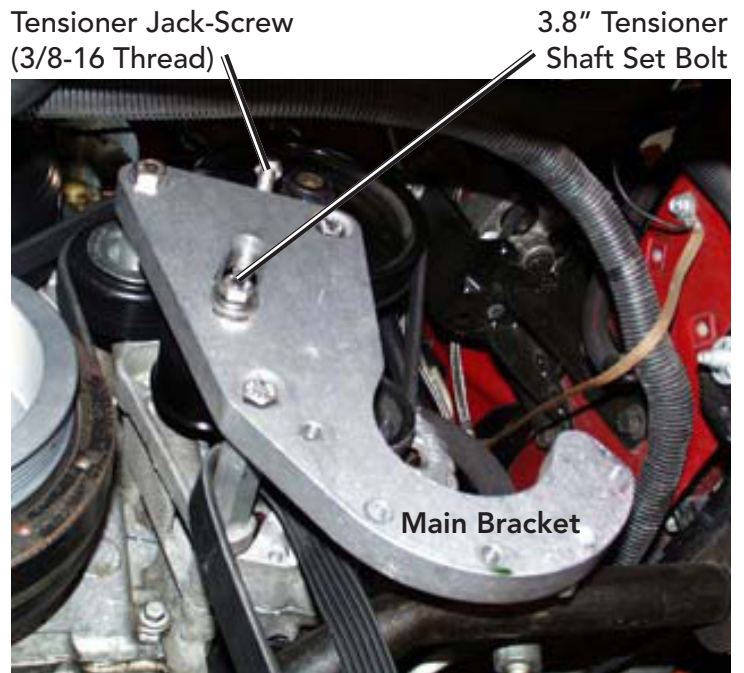

Main Bracket with Tensioner Installed

- 9 Install the ProCharger to the main bracket with the inlet facing the front of the vehicle, making sure to pass the ProCharger drive belt around the ProCharger pulley. Secure the ProCharger to the main bracket using the provided 5/16" and 3/8" socket head cap screws. Verify the belt routing matches the schematic below.
  - 10 Tension the ProCharger drive belt by tightening the 3/8" jack screw at the top of the main bracket until all slack is removed from the belt, then tighten one more turn. Now tighten the bolt on the back of the tensioner shaft to fix the tensioner in place.
  - 11 Re-tension the belt after initial stretch in period of 250 miles, or if black belt dust is noticed near the ProCharger pulley.
- ✓ **Note:** To ensure belt alignment, verify that the supercharger has the proper shim between the supercharger pulley and supercharger input shaft. Proper shim width is 0.075" for 6-rib applications and 0.200" for 8-rib applications (may be 2 shims with total width of 0.200").

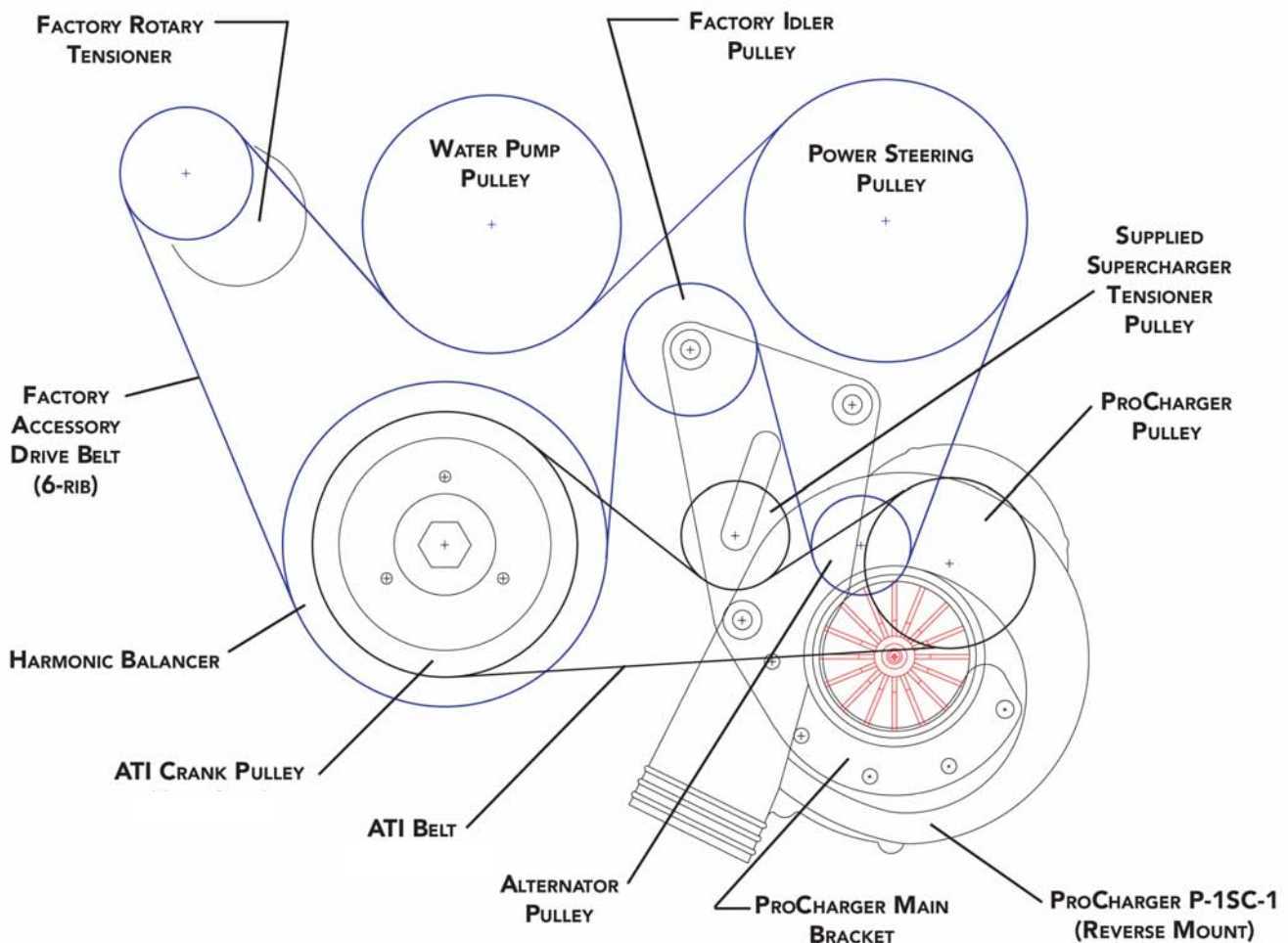

Belt Routing Schematic 6-Rib

### 8 and 10-rib applications only.

✓ **Note:** For automatic transmission vehicles, it will be necessary to disconnect the transmission cooler lines in order to install the supercharger belt. Disconnect the lines toward the front of the engine compartment where they change from hard to rubber lines. Some fluid will pour out; take safety precautions. Now slide the supercharger drive belt onto the lines and reconnect the lines. Be sure to check your fluid level before you drive the vehicle. The transmission cooler line securing tab will be reused at its existing location and it might be necessary to use the 2.65" hex standoff (also supplied) in place of the 2.75" hex standoff (2.90" instead of 3" for 10-rib applications) in order to allow the main bracket to sit flush (parallel to the front of the block).

12 Remove the factory idler pulley retaining bolt and idler set aside.

13 Using a 13mm remove the (2) bolts located in between the water pump and the power steering. Mount the supplied sub bracket to the open holes using the supplied (2) M8x 60mm SHCS. The tapped hole goes towards the top.

14 Reinstall the factory idler pulley and the accessory belt.

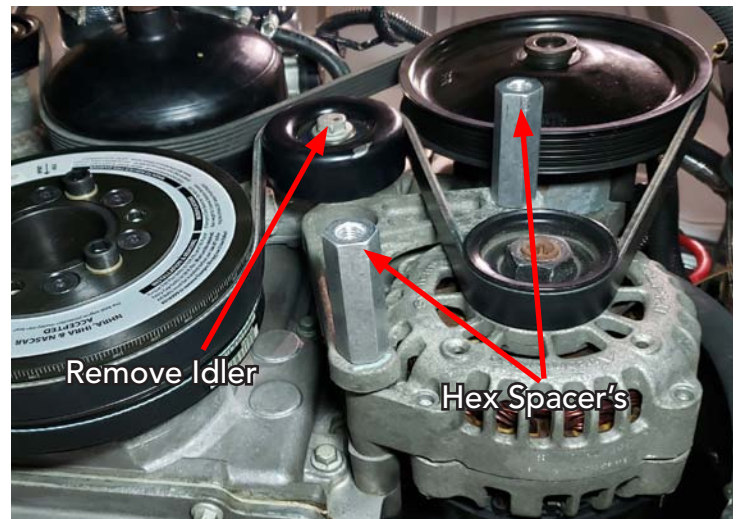

Main Bracket Standoffs Installed



Sub Bracket Installed

**15** Loosely install the supercharger belt before installing the supercharger bracket.

**16** Remove the Idler from the main bracket.

**17** Loosely Install the main bracket to the stand offs using the supplied M10 x 30mm SHCS'.

**18** Insert the 3.625" (3.760" for 10-rib) aluminum spacer between the bracket and the previously installed sub bracket secure with an M10 x 120mm SHCS. Tighten all the bracket bolts.

**19** Fill the supercharger with the supplied 6oz (4oz for "F" series) of oil.

**20** Install the ProCharger to the main bracket with the inlet facing the front of the vehicle, making sure to pass the ProCharger drive belt around the ProCharger pulley. Secure the ProCharger to the main bracket using the provided 5/16" and 3/8" SHCS.

**21** Re-install the idler pulley that was removed earlier to the main bracket.



Belt Loosely Installed



Main Bracket Installed



Procharger Installed

- 22 Route the supercharger belt following the schematic below. Use a 1/2" breaker bar to rotate the tensioner counter clockwise, route the belt then release the tensioner.

✓ **Note:** To ensure belt alignment, verify that the supercharger has the proper shim between the supercharger pulley and supercharger input shaft. Proper shim width is 0.200" for 8-rib applications (may be 2 shims with total width of 0.200"). 10-rib applications are .130" for SC trim superchargers and .065" for "F" series superchargers.

✓ **Tech Tip:** If the belt is too loose or too tight there are (3) locations for the idler pulley to mount to. Adjust the idler to best suit the belt tension.

✓ **Tech Tip:** When the car is up in the air (such as on a lift or jackstands) the swaybar will appear to be close to the crank pulley. This is only the case when the car is up in the air and only in extreme cases will happen when driving.

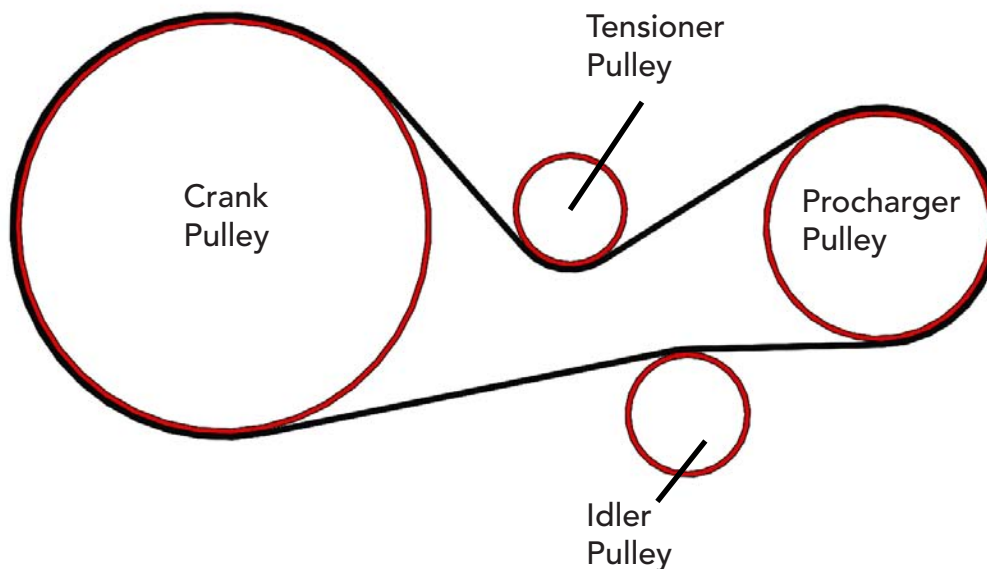

Belt Routing Schematic 8 And 10 Rib



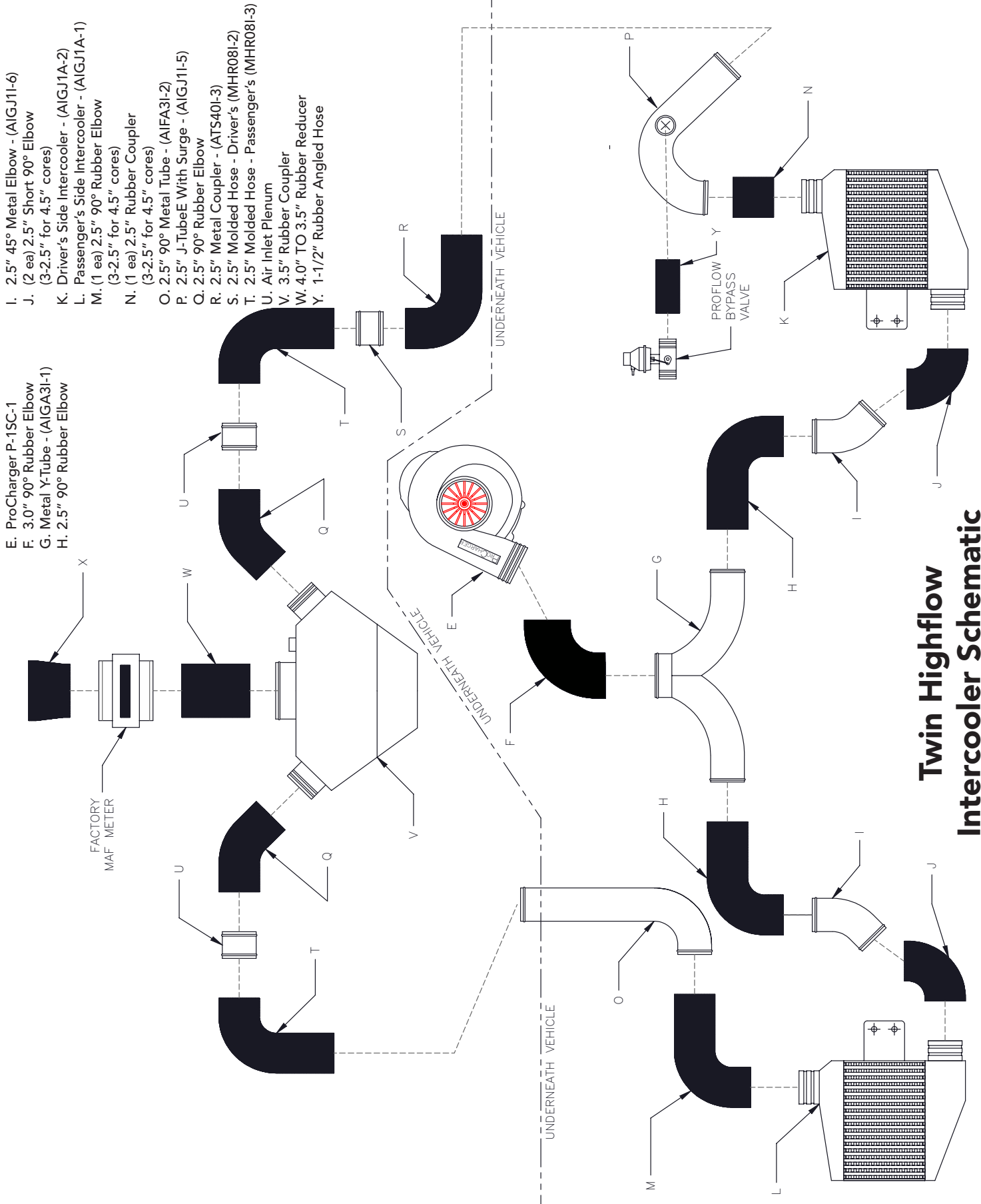

**Twin Highflow Intercooler Schematic**

# INTERCOOLER AND TUBING

✓ **Note:** Leave all clamps loose until you have installed all of the tubes and hoses. Adjust each hose and tube for best fit and then tighten all clamps. Hose installation can be eased if you first wet the metal tubes and fittings with a solution of dishwashing soap and water. Some hoses may require trimming for optimal fit; this can be accomplished using a sharp utility knife.

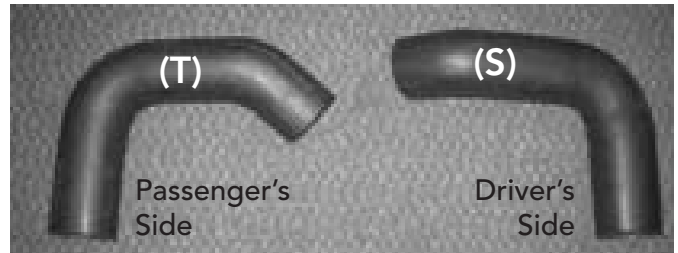

## Twin Highflow Intercoolers (see supplemental install manual for Race Intercooler upgrade)

- 1 Attach the 3" 90° reinforced rubber elbow (F) to the outlet of the ProCharger using a #52 hose clamp. Attach the 3" end of the y-tube (G) to this 3" rubber elbow.
- 2 Attach the long end of one of the 2.5" reinforced 90° elbows (H) to the driver's side of the y-tube (G) using a #40 hose clamp. The long section of the tube should be sitting horizontal and run parallel to the lower radiator core support member.
- 3 Drill two holes in the bottom of the lower radiator core support member as shown. Drop a 3/8" - 16 x 1-1/4" hex bolt into each hole from the top side and secure on the bottom with one of the 3/8" speed nuts and flat washers. These bolts will serve as mounting studs for the driver's side intercooler.

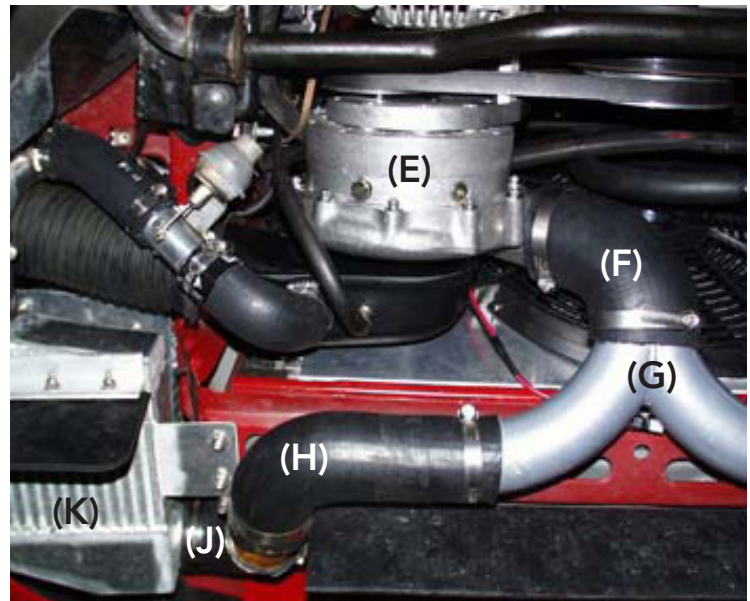

ProCharger Discharge Tubing

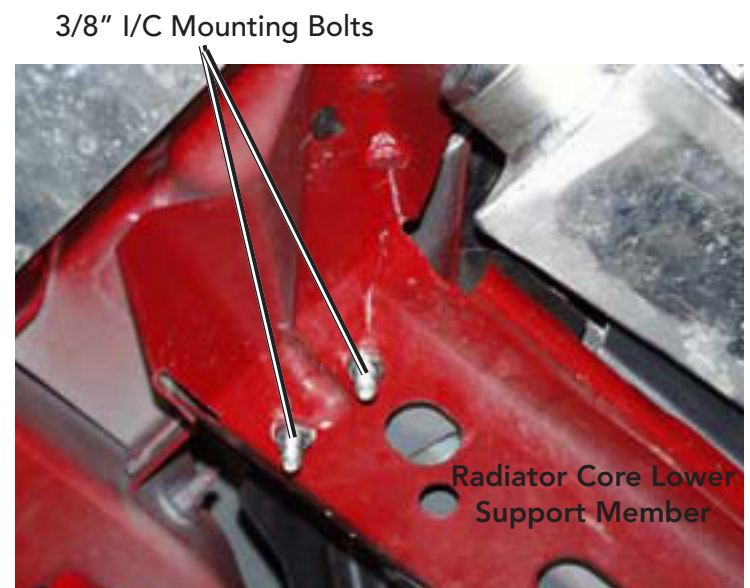

Driver's Side I/C Stud Location

- 4 Install the intercooler scoops to both intercoolers using the supplied hardware.
- 5 Install the driver's side intercooler by sliding the intercooler up into place over the previously installed bolts and secure, using the remaining 3/8" lock nuts and flat washers. Now install the short 45° steel tube (I) and the short 2.5" 90° rubber elbow (J) between the 90° rubber elbow (H) previously installed on the y-pipe and the inlet of the intercooler, using the supplied #40 hose clamps.
- 6 Repeat steps 3 and 5 for the passenger's side intercooler.
- 7 Adjust the installed tubes to give maximum ground clearance, and then tighten all hose clamps. All of the tubes between the ProCharger discharge and intercooler inlets should now be installed.
- 8 Install the 2.5" J-tube with surge fitting (P) to the outlet of the driver's side intercooler using the short 2.5" straight hose section (N) and #40 hose clamps. The straight section of the J-tube should point into the opening below the underhood fuse box.
- 9 Install the 2.5" 90° rubber elbow (M) onto to passenger's side intercooler outlet as shown using one of the #40 hose clamps. Attach the 2.5" metal 90° elbow (O) to this elbow with the straight section pointing vertical inside the lower radiator hose.



Twin Intercooler's Installed

## Intercooler and Tubing

- 10 From the top side of the engine compartment, place the LS1 air plenum (U) in position on the radiator core support, so that the outlet aligns with the throttle body. Install the 5" long piece of 3.5" hose (V) to the air plenum outlet and attach the MAF inlet to the other end using #56 hose clamps. Make sure the MAF is oriented in the proper flow direction (arrow should point into the throttle body). Install the 4" to 3.5" reducer (W) between the throttle body and MAF outlet and secure using #64 hose clamps. Re-attach the wiring harness to the MAF and Inlet Air Temperature sensors.

✓ **Note:** Make sure that the tab at the front of the air plenum hooks on to the lip of the frame.

✓ **Note:** When using the rotomold plenum the tab holes will need to be marked on the frame and 1/8" holes will need to be drilled into the frame. Secure the plenum with the supplied sheetmetal screws.

- 11 Install the 2.5" molded hose (T) between the passenger's side of the air plenum at the top and the 90° metal tube (O). Secure all hose clamps.

- 12 Install the 90° rubber elbow (Q) to the J tube with surge (P). Install the metal coupler (R) to the 90° rubber elbow (Q). Install the 2.5" molded hose (S) between the driver's side of the air plenum at the top and the metal coupler (R). If necessary, trim the rubber tube slightly to improve tube fit/routing. Secure all hose clamps. Check all hose clamps and verify all tubing is clear of moving parts.

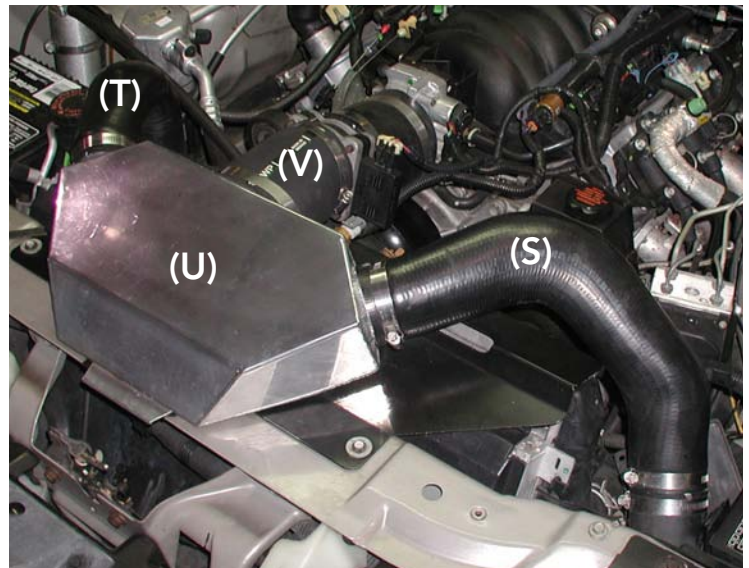

Intake Air Plenum & Tubing Installed

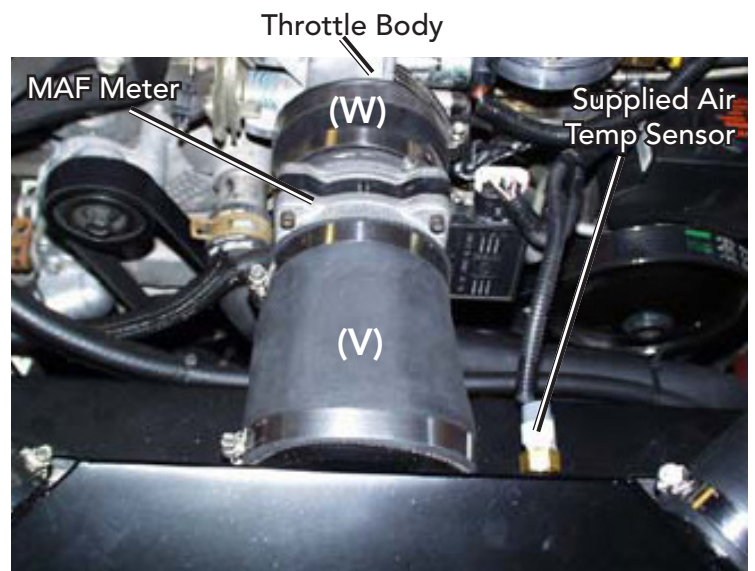

MAF Meter & Tubing Installed



Rotomold Plenum Installed

## Air Inlet/Surge System

- 13 Using a 3/8" drill bit, drill a hole in the end of the air filter. Put the provided 3/8" 90° plastic fitting (located in the PCV bag) into the hole.
- 14 Assemble the provided rotomold inlet pieces, rubber coupler and filter as shown to the right. Keep the #56 hose clamps loose till the air inlet is in place in the vehicle.
- 15 Insert the air inlet assembly into the vehicle. Place the air filter section between the surge tube and the intercooler as shown below. Place the other end of the inlet tube onto the inlet of the supercharger loosely secure with a #56 hose clamp. Position the filter and tubing and secure all hose clamps at this time.



Plastic Fitting Installed Into Filter



Air Inlet Assembly



Air Inlet Installed

## Intercooler and Tubing

- 16 Assemble the provided vacuum manifold as shown. Additional fittings have been provided to connect to a boost gauge.
- 17 Locate the brake booster hose on the driver's side near the firewall. Remove a 3-1/2" section of this hose in order to place the manifold in-line.

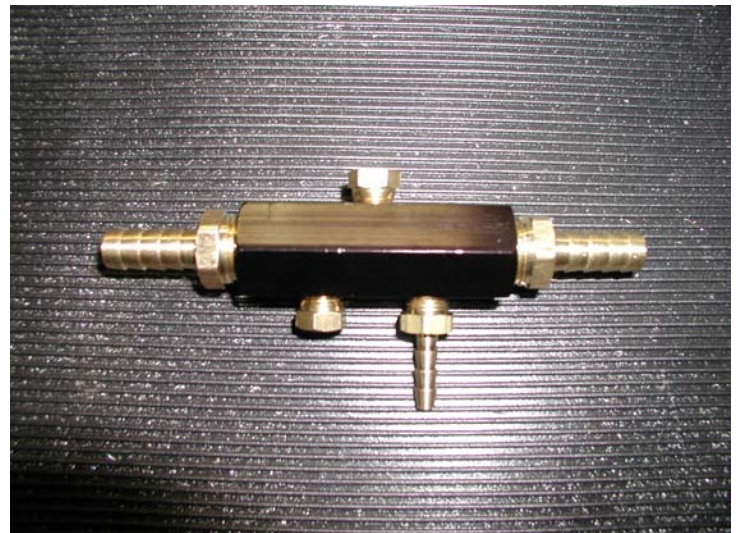

Vacuum Manifold Assembled

- 18 Mount the manifold by sliding each barbed fitting into the open ends of the brake booster hose. Secure the connections with the provided #06 hose clamps.



Vacuum Manifold Installed

- 19 Be sure the brake booster hose connections are tight; verify the connection to the booster did not come loose as well.



**Note:** Improper clamping of the splice into the brake booster hose could cause a vacuum leak and could cause the power brakes to become inoperable. Use extreme caution in installing the vacuum manifold to prevent any possible leaks.

- 20 Attach the provided 1-1/2" rubber hose to the surge bung on J-tube (P), followed by the surge valve. Place the filter onto the end of the valve. Position the valve so the mechanical linkage is not obstructed.
  
- 21 Secure the surge valve connections with #24 hose clamps.
  
- 22 Route the supplied 3/16" vacuum line from the port on the vacuum manifold to the port on top of the surge valve. Be sure to keep the line away from any heat sources or moving objects. Secure the line with the provided zip-ties.



Surge Valve Assembly Installed

# FUEL SYSTEM

✓ **Note:** This section only applies to full systems, which include an in-line fuel pump and new fuel injectors. If you do not have a full system, additional fuel system modifications will be required before starting the vehicle.

! **Warning:** When working on high pressure fuel systems, caution should be taken when handling high pressure lines, as residual pressure may cause fuel to spray unless relieved prior to disconnection. Take precaution to avoid injury or fire.

## Fuel Pump/Lines

- 1 From the top of the engine compartment, mount the supplied fuel pump relay and the short 6-1/2" ground wire to the ground stud. Use the supplied M6 nut and washer to secure the relay and ground wire to the stud.
- 2 Mount the red wire to the factory positive terminal post.
- 3 Lift up on the fuse box assembly to release it from its clips. Using a flat head screwdriver, release the tab on the fuse box closest to the front of the car while pulling up on it at the same time. This should release it from the assembly and allow you to gain access to the wiring on the underside.

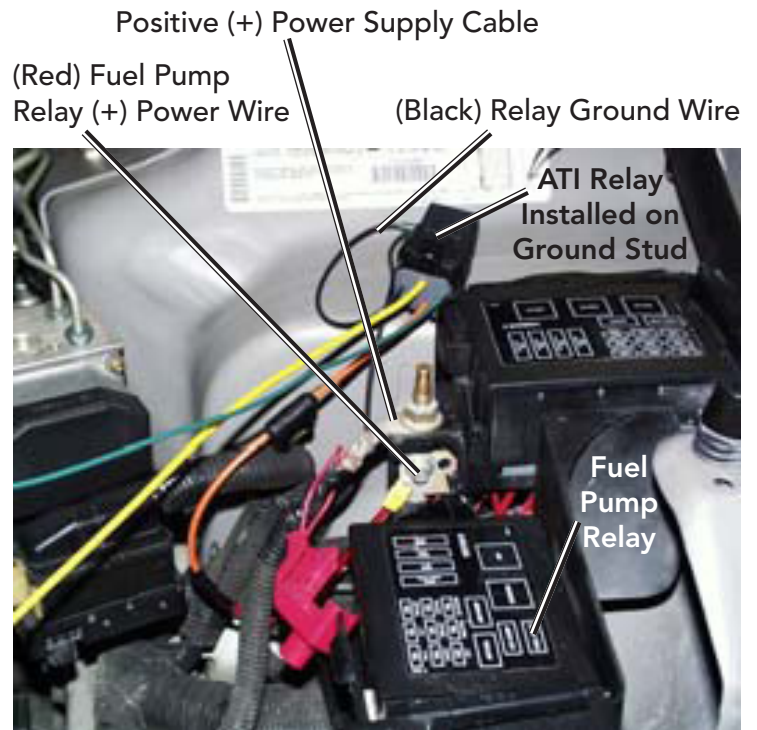

Fuel Pump Wiring & Relay Installed

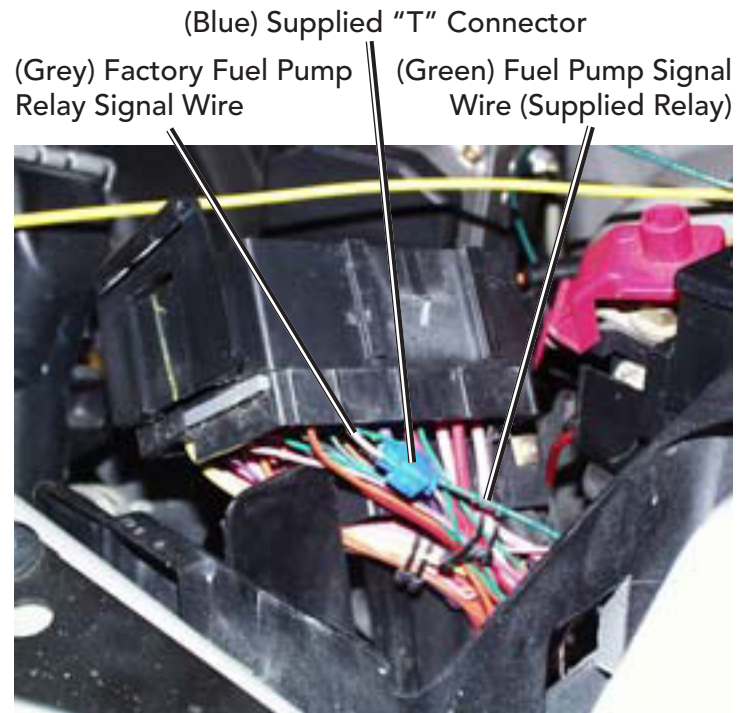

Fuel Pump Signal Wire Installation



- 4 Using the supplied blue electrical "T" connector, connect the green wire from the relay to the solid grey wire coming out of the fuse location for the fuel pump. The location is labeled 'fuel pump' on the lid to the fuse box. Use pliers to depress the metal prong into the wires and make sure that the flap closes properly.
- 5 Route the yellow wire (from the relay) along the same path as the stainless steel line all the way back to the fuel filter location. Use zip ties to secure the wire.
- 6 Re-install the heat shields. Make sure that the stainless steel line and the yellow wire are not interfering with anything and that they are both clear of the steering components.

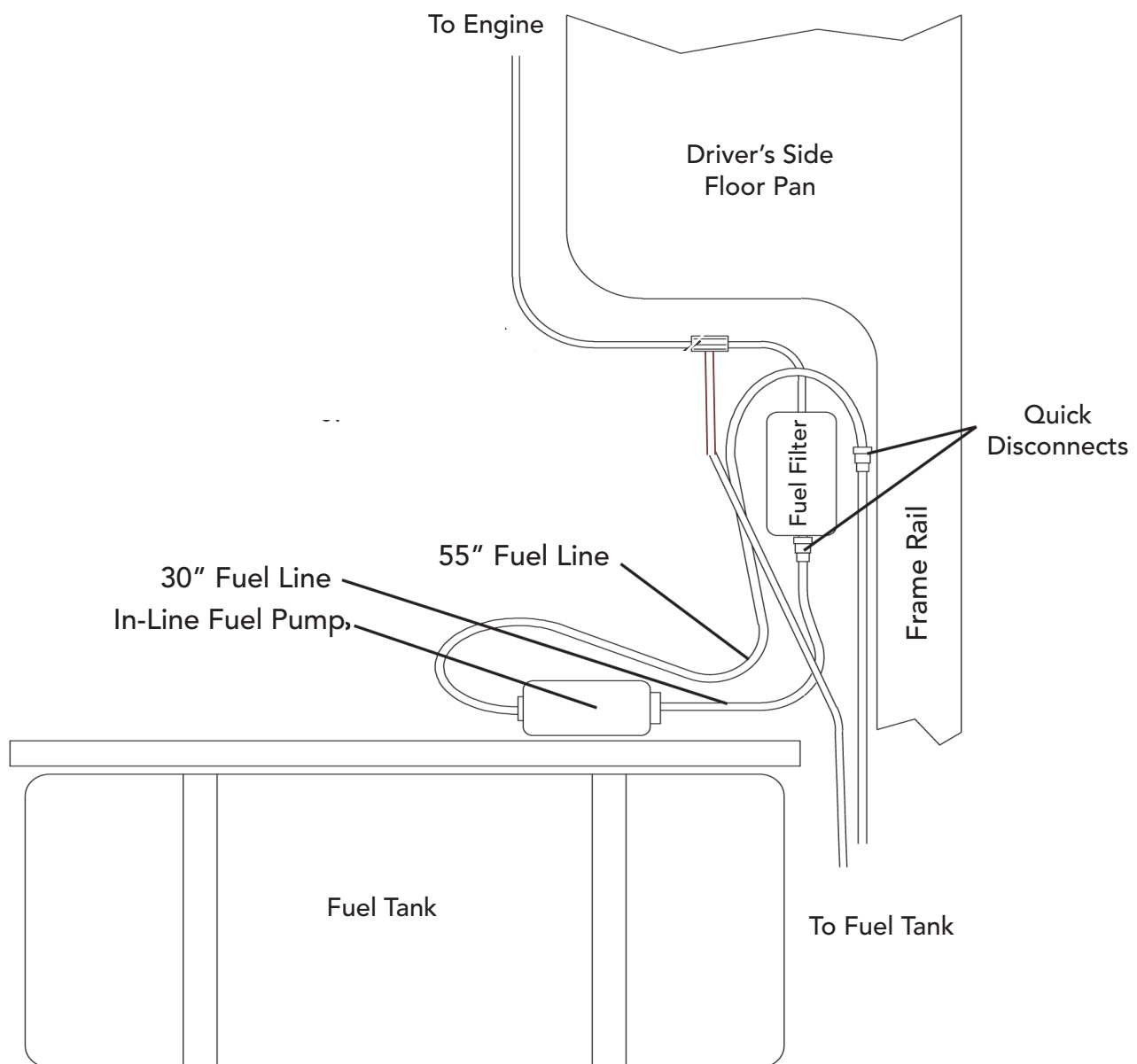

Fuel Pump Installation Schematic

- 7** Remove the panels containing the rear speakers in the trunk. Unlock the passenger's side fasteners by turning them with a flat head screwdriver. Remove the driver's side panel (held down with plastic 'tree rivets') by carefully pulling straight up on the panel. You will need to unclip the speaker wires from the speakers to completely remove the panels.
- 8** Remove the two metal tie downs using a #40 Torx bit.
- 9** Push the levers (on either side of the back seat) towards the front of the car to fold the seat down.
- 10** Using a #50 Torx bit, remove the two pins on either side of the back seat side panels.
- 11** If your car is a T-top vehicle, use a Phillips head screw driver to remove the end caps that keep the back seat side panels in place. These caps are located at the upper forward most part of the back seat side panel.
- 12** Remove the back seat side panels by sliding them forward and pulling them away from the side walls.
- 13** Pull back the carpet to expose the sheet metal behind the rear seat.



Carpet Removed From Rear of Vehicle

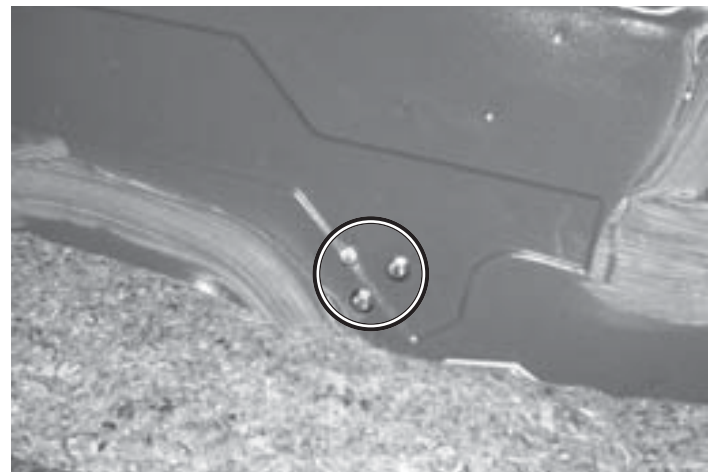

Fuel Pump Mounting Bolts (Inside Vehicle)



Fuel Pump Mounting Location  
(Under Vehicle, Above Rear Axle)

**14** From underneath the car, place the fuel pump bracket and fuel pump (not installed yet) up into the area shown at lower left. Make sure the location is high and out of the way, and that the outlet and inlet hoses do not interfere with anything. Hold the bracket in place and remove the pump. Use the bracket to mark the (3) mounting holes. Make sure that there is nothing on the other side of the sheet metal that could be damaged.

**15** Use a 5/16" drill bit to drill the holes (start out with a small bit to locate the hole, and then move to the 5/16" bit to finish). Drill one of the holes first, and check the other side to confirm that there are no obstructions for the rest of the holes.

**16** Drop the supplied 1/4-20 x 1" mounting bolts with washers through the holes from the inside of the car. Place the fuel pump bracket (with grommets installed) onto the bolts and secure the bracket with the supplied nuts and washers. This will require (2) people, one on each side.

**17** Roll the carpet back into position and re-install the interior components in reverse order of disassembly.

**18** The fuel pump should already have its inlet and outlet lines connected to it, but if not, go ahead and install the lines on the pump. The 55" line goes on the inlet side of the pump while the 30" line goes on the outlet side of the pump. The outlet is labeled and is the end with the +/- terminals. Using the supplied brass nut and lock washer, install the 18" black wire to the negative terminal of the pump.

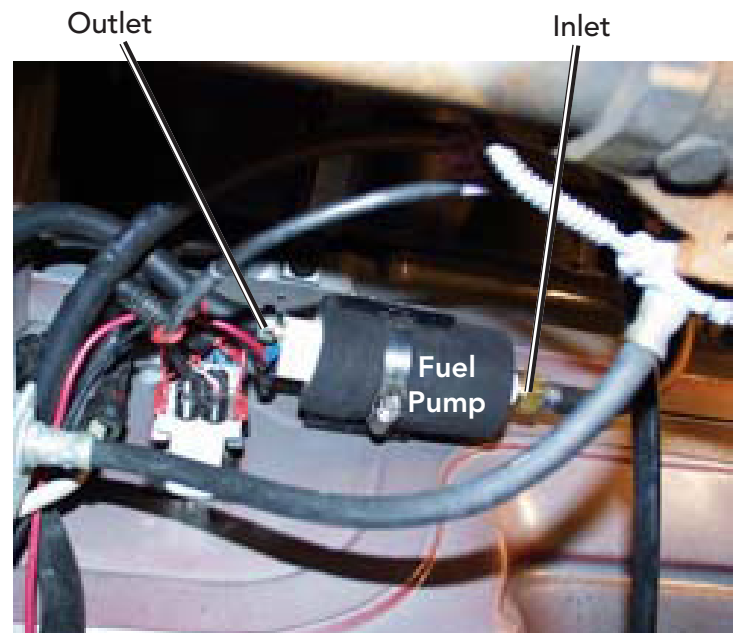

Fuel Pump Installed

Ground Wire Installed



Fuel Pump Ground Mounting Location

- 19 Using the supplied #32 hose clamp, mount the fuel pump to its bracket, making sure the outlet end is pointed towards the driver's side rear wheel. The ground wire can then be mounted at the bolt location for the bracket that secures the rear brake lines.
- 20 Continue running the yellow wire (from the relay) along the fuel lines up to the fuel pump. This is the positive wire for the pump. Cut the wire at the appropriate length and crimp on the supplied (yellow) ring terminal. Then connect it to the positive terminal on the pump using the supplied lock washer and brass nut.
- 21 Disconnect the fuel line going into the fuel filter by pressing in on the plastic tabs while pulling the connection apart. Make sure that the (white) plastic retainer does not stay on the fuel filter. Use a screw driver to release the tabs if the filter is stuck on the fuel filter inlet.
- 22 Connect the 30" fuel line from the pump outlet to the fuel filter inlet. The quick disconnect fitting should snap when it is locked onto the fuel filter inlet.
- 23 Connect the 55" fuel line from the pump inlet to the fuel line that was disconnected from the fuel filter. You should hear them snap together when they are locked.
- 24 Make sure all fuel lines and wiring are securely wire tied out of the way.



Fuel Pump Lines Installed

## Fuel Injectors

- 1 Disconnect the negative battery cable if not already done. Cover the fuel rail with a shop towel and depress the bleeder valve (driver's side of fuel rail) to release any residual fuel pressure.
- 2 Remove the four fuel rail retaining bolts.
- 3 Depress the fuel injector wiring harness connector clips and unplug each connector.
- 4 Remove the injector retaining clips and remove each injector.
- 5 Replace the factory injectors with the supplied units. Lubricate the o-rings with a small amount of fresh engine oil before installing.
- 6 Reconnect the wiring harness and re-install the fuel rail retaining bolts.



Fuel Rail Bleeder Valve

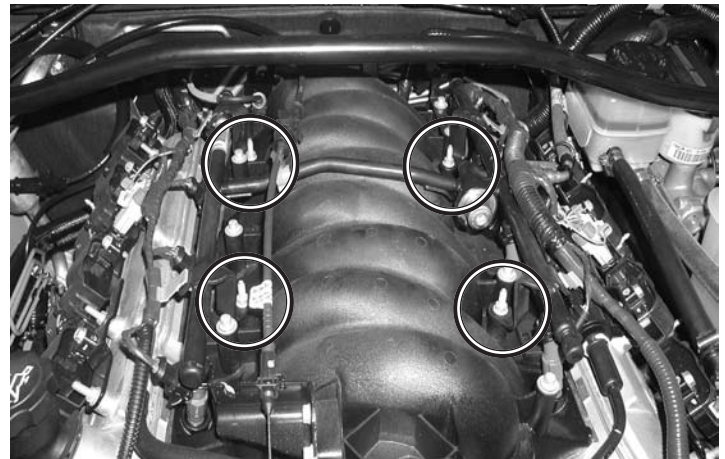

Fuel Rail retaining Bolts

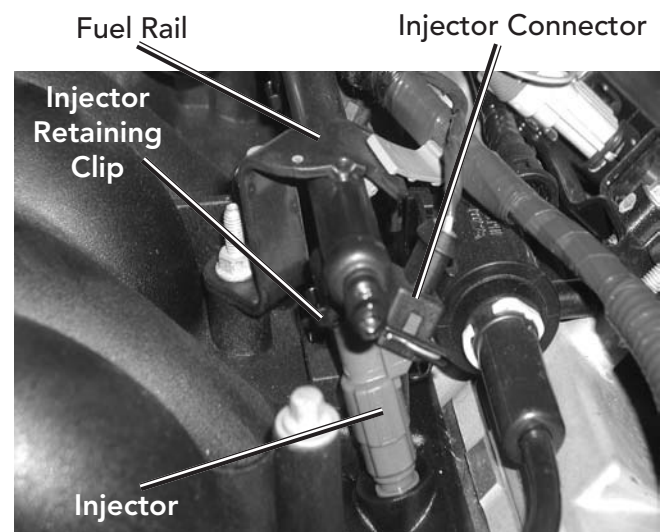

Injector Removal

# FINAL ASSEMBLY

- 1 Remove the crankcase vent line coming out of the passenger's side valve cover and from the side of the throttle body. Place the supplied 3/8" rubber cap over the tube where the breather was connected and secure with a wire tie.
- 2 Attach the supplied 3/8" breather hose to the fitting on the passenger's side valve cover and then route this hose to the blower inlet hat. Secure both ends with the supplied hose clamps. Make sure the line is out of the way of any moving parts.
- 3 Check all fluids and correct levels as necessary.
- 4 Reconnect the negative battery cable.
- 5 Re-install the sway bar if removed.

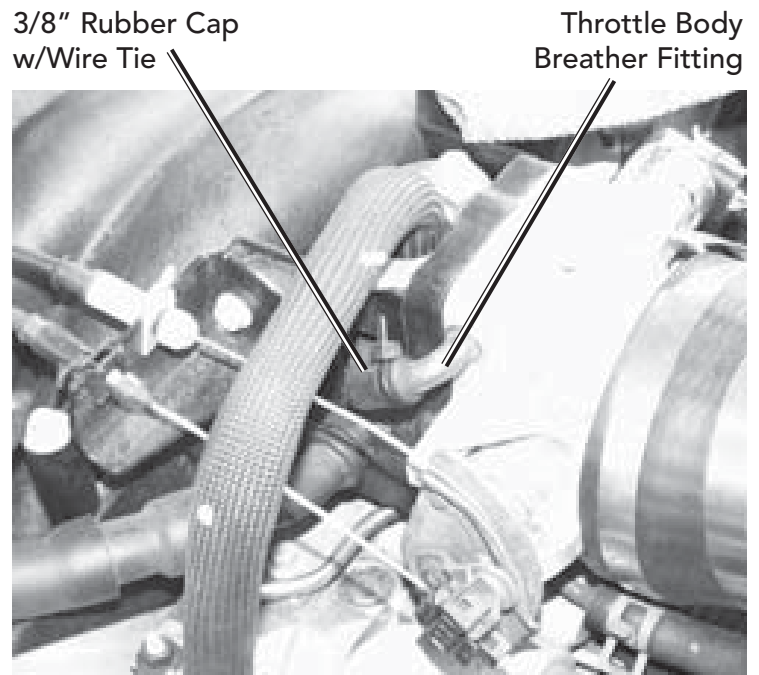

3/8" Rubber Cap  
w/Wire Tie

Throttle Body  
Breather Fitting

Throttle Body Breather Fitting Capped

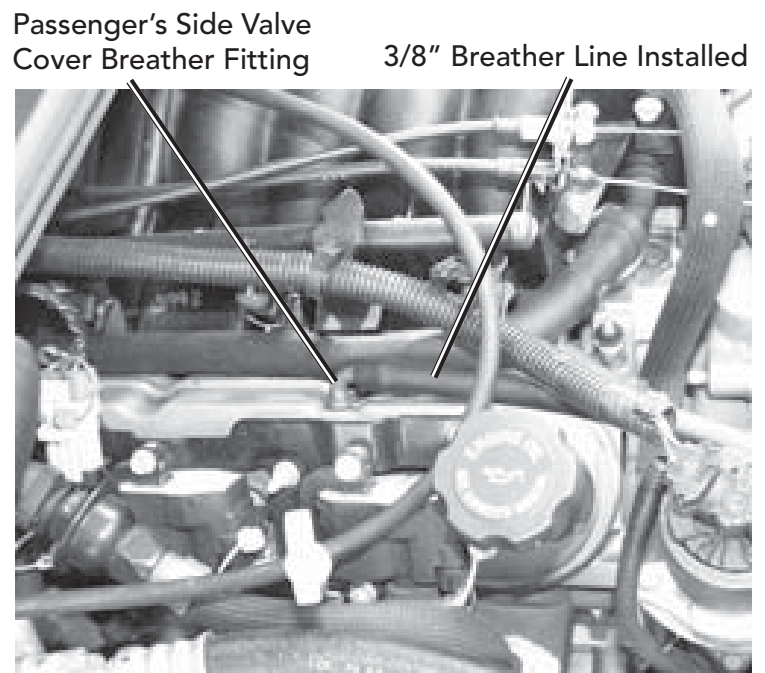

Passenger's Side Valve  
Cover Breather Fitting

3/8" Breather Line Installed

Passenger's Side Valve Cover  
Breather w/New Hose

# INSTALLATION REVIEW/SAFETY CHECK

- 1 Carefully review the entire installation. Examine oil and fuel lines routed near moving parts and exhaust components to ensure that they are protected from chafing or abrasion, secure and free of twists and kinks. All wires and hoses should be firmly secured with clamps or wire ties.

- 2 Ensure that the air filter is installed.

- 3 Check and correct all fluid levels.

✓ **Note:** Your vehicle **MUST** be filled with 91 or higher octane fuel before any hard driving. You should switch to 91 octane 2 or 3 tanks of gas prior to installation of the ProCharger system in order to guarantee removal of low octane fuel from your vehicle

- 4 **The supercharger contains no oil from the factory. The unit must be filled prior to use.** Use only ATI supplied oil in your ProCharger. The ATI oil has been specially formulated for the bearings in the ProCharger and use of oil other than that supplied by ATI will void your warranty.

- 5 Start the engine and let it idle for a few minutes. Inspect for air leaks.

- 6 Shut off the engine and check for fluid

leakage, signs of rubbing parts, and other potential problems.

- 7 Be sure you have purchased and installed a fuel pressure gauge and/or fuel-air ratio meter to monitor fuel delivery while driving. Installation of a boost pressure gauge is also recommended.

✓ **Note:** Larger cities (especially in winter months) often use oxygenated or reformulated fuels to reduce pollution. Although these fuels have the same octane ratings as unaltered fuels, some people have experienced problems (detonation) with their use. If you experience similar problems, it is advised to reduce your timing or use octane booster to avoid detonation.

**Congratulations! You have successfully completed the installation of your new ProCharger supercharger system!**

**Please continue reading the following pages for important information about tuning and maintaining your system.**

# OPERATION AND MAINTENANCE

## Cold Starting

Never race your engine and ProCharger supercharger when your engine is cold. Allow the water temperature to climb into operating range for several minutes before driving above 2,500 rpm, to ensure adequate oil lubrication.

## Ignition System Maintenance

Because of the vastly cooler intake temperatures delivered by intercooling, You should be able to run full timing on your intercooled ProCharger application, but be aware that with forced induction and full timing your vehicle will continue to pull hard all the way to the redline, and for maximum performance you should now shift just prior to the redline. Avoid hitting the Rev-Limiter, as the factory computer shuts off fuel delivery, resulting in a dangerous lean condition, detonation and possible engine damage. If your spark plugs are more than a year old or have more than 10,000 miles logged, you should consider changing them before driving your vehicle under load. Spark plug wires should be changed if visibly damaged or when resistance exceeds factory specifications.

## Air Filter Maintenance

Your air filters should be cleaned periodically, potentially as often as every 10,000 miles or 6 months, even though a service interval of 50,000 - 100,000 miles is quoted by the manufacturer under normal driving conditions. A clogged air filter will result in decreased boost levels and vehicle performance. Be sure to re-oil the cleaned filter before re-installing. Always operate your vehicle with an air filter, failure to do so may result in damage to your ProCharger supercharger and personal injury!

## Fuel Quality

With a properly installed intercooled ProCharger supercharger system, detonation should not occur. For the best performance and reliability, use premium grade fuel (91 octane or higher). Listen for signs of detonation after refueling, and after replacement or modification of any fuel system component(s). If detonation occurs, reduce the throttle and locate the source.

## Belt Replacement

The serpentine belt, which turns your ProCharger supercharger, will stretch after initial run-in, and should be retightened after the first hundred miles. Tighten the belt sufficiently to avoid slippage, but do not overtighten. Overtightening the belt could cause damage to the ProCharger supercharger's precision bearings. When re-installing the belt, use the belt routing diagram in this manual. If you reuse a thrown belt and find that it needs frequent re-tightening, the belt is damaged and should be replaced. Gates Micro-V belts can be bought from ATI or from your local parts store.

## Impeller Speed

**Maximum impeller speed should not exceed the impeller redline speed of 65,000 rpm for the P1SC-1 model.** To determine the impeller speed, the following formula is used: Maximum impeller speed = crankshaft pulley diameter (N1) divided by supercharger pulley diameter (N2), multiplied by the step-up ratio (4.10 for the P1-SC multiplied by engine rpm at redline.

$$\text{Impeller RPM} = (N1/N2) \times (4.10) \times \text{engine RPM}$$



## ProCharger Oil Level

The ProCharger supercharger's oil level must be checked periodically to ensure the proper lubrication. The dipstick can be loosened using a flat blade screwdriver or a coin. When installed, the oil level should remain between the minimum (MIN) and maximum (MAX) indicators at all times.

**!** **Warning:** Filling the ProCharger higher than the maximum level on the dipstick can lead to bearing and seal damage. The supercharger is a sealed unit and should not normally require the addition of oil between service intervals. If excessive usage is noted, the unit should be sent to ATI for inspection and repair. The dipstick fitting should be firmly tightened after changing or checking the oil level.

## General

When removing the dipstick, be sure to retain the nylon washer. A spare nylon washer and o-ring is included. Use only the ATI supplied nylon washer and o-ring when servicing the oil dipstick and drain plug. A discoloration of the oil and residue on the drain plug may occur during the initial oil changes. This is normal and will gradually decrease. For the proper positioning of the ProCharger supercharger, the serial tag should be pointing upwards. Installing the ProCharger supercharger in another position will cause inadequate oiling and supercharger failure. If you have any questions about the maintenance of your supercharger, contact ATI.

**!** **Warning:** The supercharger contains no oil from the factory. The unit must be filled prior to use. Use only ATI supplied oil in your ProCharger. The ATI oil has been specially formulated for the bearings in the ProCharger and use of oil other than that supplied by ATI will void your warranty.

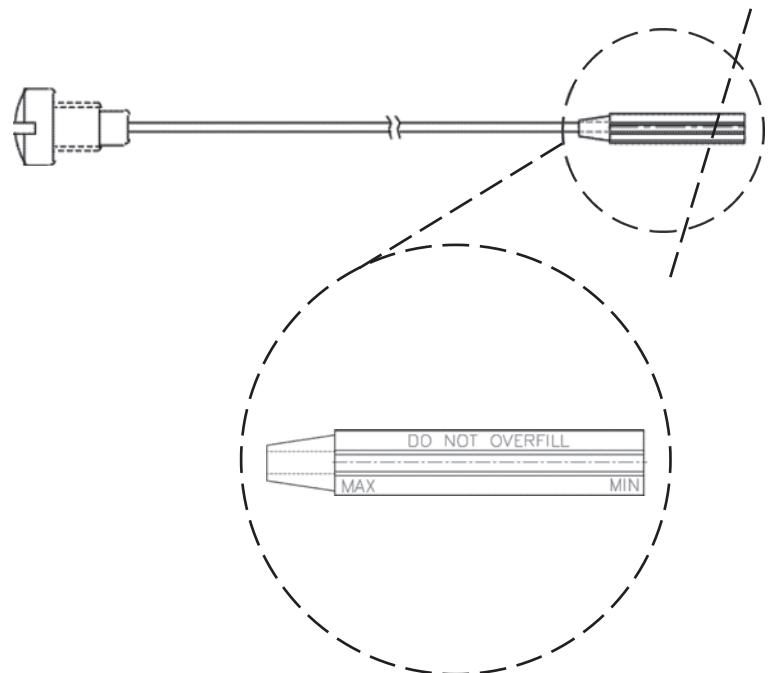
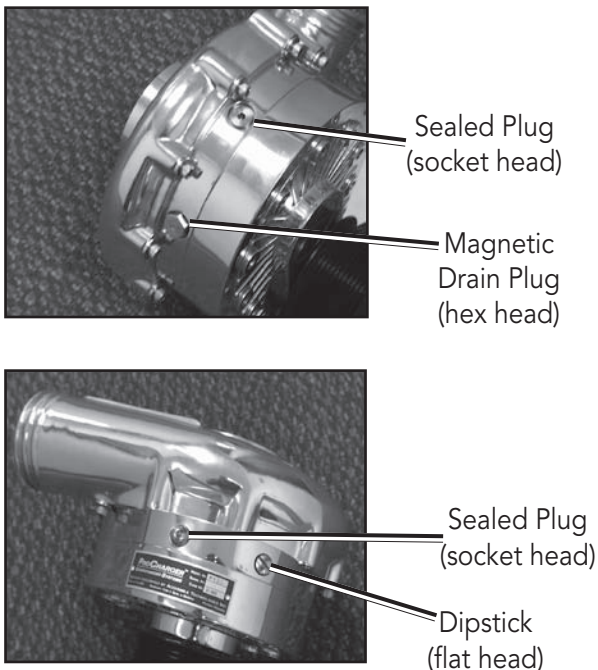

# LIMITED WARRANTY

Accessible Technologies, Inc. (ATI) provides a limited twelve (12) month warranty on the ProCharger supercharger against defects in materials and workmanship unless otherwise specified. This limited warranty starts on the date of original purchase from your local dealer, or date of shipment from the factory. This limited warranty coverage is extended only to the original owner and excludes hoses, sleeves, and electronic components manufactured by other companies. IF THE SUPERCHARGER'S DRIVE RATIO IS ALTERED IN ANY WAY FROM THE FACTORY SETTING, WARRANTY COVERAGE IS VOID. USE OF ANY PULLEY NOT MANUFACTURED OR SUPPLIED BY ATI VOIDS ALL WARRANTY COVERAGE.

ATI's warranty obligations are limited to the terms below:

ATI agrees to honor a warranty claim at its sole discretion and only after inspection at the ATI factory. No warranty will be honored if any part of the product is found to have been improperly installed, tampered with, mishandled, or misused in any way. Disassembly of the ProCharger supercharger or removal of the ProCharger supercharger's serial plate voids all warranties. Claims for freight damages should be directed to the freight company.

If ATI's limited warranty applies, your product will be repaired or replaced at ATI's discretion and shipped back. If the limited warranty does not apply, ATI will advise you of the specific reason, cost of the repair, and delivery time. After advising you of this information we will, at your option, either proceed with repairs or return your product to you in the state in which it was received. In either case the product will be shipped to you, insured at replacement value. Therefore, you will pay the return shipping and insurance charges if ATI's limited warranty does not apply to your product.

THE WARRANTY AND REMEDIES SET FORTH ABOVE ARE EXCLUSIVE AND IN LIEU OF ALL OTHERS, ORAL OR WRITTEN, EXPRESS OR IMPLIED. THE DURATION OF ANY AND ALL WARRANTIES ON THE PRODUCTS DISCUSSED ARE LIMITED TO THE PERIOD IDENTIFIED ABOVE. ATI IS NOT RESPONSIBLE IN ANY EVENT FOR DIRECT, SPECIAL, INCIDENTAL OR CONSEQUENTIAL DAMAGES. No ATI dealer, agent, or employee is authorized to make any modification, extension, or addition to this warranty.

**To obtain service under this warranty you must do the following during the warranty period:**

Phone ATI (913-338-2886) and provide us with the following information:

- ProCharger supercharger serial number.
- Vehicle year, make, model, engine modifications, and other modifications.
- Description of perceived issue.

If a solution to your issue can not be found after the above phone consultation, you will be assigned a return authorization number (RMA). You must then properly package and ship your product, at your expense, to the ATI factory. The product should be carefully packaged in a rugged box.

**Include the following information inside the box with your product:**

- Copy of your original invoice or receipt.
- Name, address, and daytime telephone number.
- Return authorization number (RMA).
- Vehicle year, make, model, engine modifications, and other modifications.
- Description of perceived issue.

Clearly mark the warranty claim number on the top and one side of the box in characters at least 2" tall. Properly package the product and ship it, prepaid and insured for the retail value of the component(s) being returned, to the following address:

**Accessible Technologies, 14801 West 114th Terrace,  
Lenexa, Kansas 66215**

## PROCHARGER EXTENDED COVERAGE

The ProCharger Extended Coverage Program extends the ProCharger warranty coverage for an additional twenty-four (24) months, for a total of thirty-six (36) months or three years of coverage. This extended coverage applies to parts for the ProCharger supercharger head unit only and does not include other system components. With your extended coverage registration, you will receive two (2) additional boxes of ProCharger Supercharger oil.

Under the extended coverage program, Accessible Technologies, Inc. (ATI) will repair or replace any component within the supercharger head unit which is found to be defective. Only the supercharger head unit itself is included in the extended coverage.

Service under the extended coverage program is obtained through the same process as described in the Limited Warranty.

Race kits are not eligible for the ProCharger Extended Coverage Plan

### To qualify for the ProCharger Extended Coverage:

- Only the original owner of the ProCharger supercharger is eligible.
- Completion of the Extended Coverage Registration Form is required, along with a \$99 registration fee. This form must be completed in its entirety, and must be submitted along with payment within 30 days from the date of original purchase from your local dealer or date of shipment from the factory.
- Participants must have a ProCharger P-1SC, P-1SC-1, P-1X, C1, or C2 supercharger head unit using the maximum warranted boost level. All terms and conditions within "The Limited Warranty" apply. Acts resulting in disqualification include but are not limited to the following:
  - Disassembly or modification the ProCharger supercharger.
  - Removal or attempted removal of the ProCharger drive pulley(s).
  - Removal or attempted removal of the ProCharger supercharger serial number plate.
  - Removal or attempted removal of the compressor housing or transmission case.
- Participants agree to properly maintain the ProCharger supercharger and provide proof of compliance with the following recommended maintenance:
  - Change the ProCharger supercharger oil after the initial break-in period of 500 miles (automotive) or 15 hours (marine).
  - Change the ProCharger supercharger oil every 6,000 miles after the initial break-in period.
  - Use only the specified amount of ProCharger Supercharger oil in the ProCharger supercharger.
  - Inspect and clean the magnetic drain plug at every ProCharger supercharger oil change.
  - Check the ProCharger supercharger oil level frequently.

This Page Intentionally Left Blank

# ProCharger Extended Coverage Program Registration Form

Return this completed form and a \$99 check within 30 days of original purchase.

Name: \_\_\_\_\_

Date of Purchase: \_\_\_\_\_

Address: \_\_\_\_\_

Purchased From: \_\_\_\_\_

City: \_\_\_\_\_

ProCharger Serial #: \_\_\_\_\_

State: \_\_\_\_\_ Zip: \_\_\_\_\_

Vehicle Year: \_\_\_\_\_

Daytime phone: \_\_\_\_\_

Vehicle Make: \_\_\_\_\_

Evening phone: \_\_\_\_\_

Vehicle Model: \_\_\_\_\_

E-mail: \_\_\_\_\_

Please rank in order of importance starting with 1 being most important.

Age  18 - 24  25 - 34  35 - 44  
 45 - 54  55 and up

Which information sources most influenced your decision to purchase a ProCharger system?

Income  \$15,000 - \$29,000  \$30,000 - \$44,000  
 \$45,000 - \$69,000  \$70,000 and up

- \_\_\_ Magazine advertising
- \_\_\_ Dealer recommendation
- \_\_\_ ProCharger Brochures
- \_\_\_ Witnessed performance on a car
- \_\_\_ Test drive
- \_\_\_ Magazine editorials
- \_\_\_ Friends
- \_\_\_ Conversations with ATI technicians
- \_\_\_ Web Site (please specify) \_\_\_\_\_
- \_\_\_ Other (please specify) \_\_\_\_\_

What magazines do you read?

- Car & Driver
- Car Craft
- Chevy High Performance
- Four Wheel and Off Road
- Hot Rod
- Motor Trend
- Muscle Mustangs and Fast Fords
- GM High-Tech Performance
- 5.0 Mustang
- Super Street
- Mustang Monthly
- Truck Trends
- Popular Hot Rodding
- Road & Track
- Sport Truck
- Super Chevy
- Truckin'
- Street Truck

What most influenced your decision to purchase a ProCharger system?

- \_\_\_ Reliability
- \_\_\_ Standard warranty
- \_\_\_ Extended coverage warranty
- \_\_\_ Performance
- \_\_\_ Quiet operation
- \_\_\_ Removability (ability to return car to stock)
- \_\_\_ Cost
- \_\_\_ Ease of Installation

Who installed your ProCharger system?  Self  Dealer  Other \_\_\_\_\_

Have you own a forced induction system previously?  Yes  No

If yes:

Supercharger: Brand(s) \_\_\_\_\_ Vehicle(s) \_\_\_\_\_

Turbocharger: Brand(s) \_\_\_\_\_ Vehicle(s) \_\_\_\_\_

I have read and understand the policy for the ProCharger Extended Coverage Program. I have not and will not modify my ProCharger supercharger in any way during my participation in the extended coverage program. I have read and answered all questions on this form. I have enclosed my check for \$99, payable to ATI, for enrolling my ProCharger supercharger (serial number indicated above) in the extended coverage program for an additional twenty-four (24) months beyond the standard limited warranty period of twelve (12) months.

Signature \_\_\_\_\_ Date \_\_\_\_\_

Mail this completed registration form with a \$99 check to ATI at: 14801 West 114th Terrace, Lenexa, KS 66215. If you have any questions, contact us at techserv@procharger.com or (913) 338-2886 8:30 AM - 5:30 PM CST, Monday - Friday.

cut along the dotted line

cut along the dotted line

This Page Intentionally Left Blank

This Page Intentionally Left Blank



**Accessible Technologies, Inc.  
14801 W. 114th Terrace  
Lenexa, KS 66215  
Phone: 913.338.2886  
Fax: 913.338.2879  
techserv@procharger.com**

**Accessible Technologies, Inc.  
©2021 ATI, All Rights Reserved  
Part Number PMGJ1A-001 Rev. E**

